

User Manual

Contents

ALDI guarantees that our exclusive brand products are developed to our stringent quality specifications. If you are not entirely satisfied with this product, please return it to the nearest ALDI store within 60 days from the date of purchase, for a full refund or replacement, or take advantage of our after sales support by calling the supplier's Customer Service Hotline.

AUS

Made in China

GARDENLINE® is a registered trademark of ALDI Stores

DISTRIBUTED BY:

ALDI STORES

1 SARGENTS ROAD

MINCHINBURY NSW 2770

www.aldi.com.au

AFTER SALES SUPPORT

58903 

 **1300 855 831**

 **support@scheppach.com.au**

MODEL: Garden 5 in 1 Petrol Tool

02/2018

3

YEAR WARRANTY



GARDEN 5 IN 1 PETROL TOOL



CAUTION!: Read the manual carefully before operating this machine!

Vers.No. 171120

Original Instructions



Overview	04
Contents of box	06
Utilisation	07
Warranty Details	12
Explanation of symbols	13
Introduction	15
Layout	16
Scope of delivery	16
Intended use	17
General Safety Warnings	18
Technical data	22
Before starting the equipment	24
Attachment and operation	25
Working instructions	31
Maintenance	38
Cleaning / Storage / Transport	43
Disposal and recycling	45
Troubleshooting	45
Repair and Refurbished Goods or Parts Notice	47

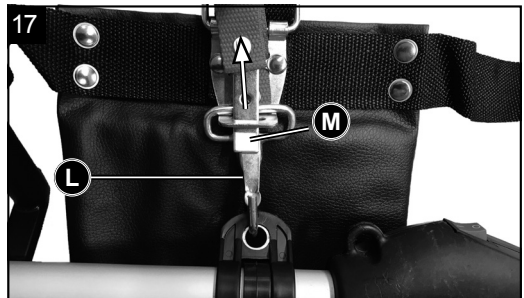
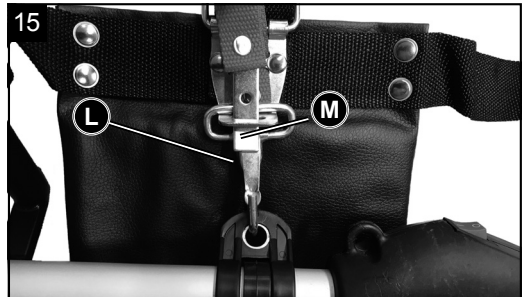
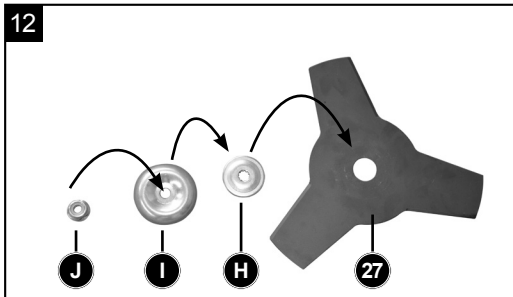
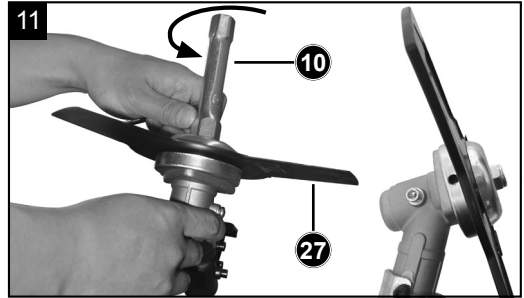
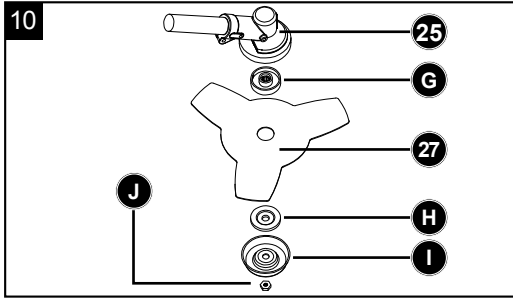

AFTER SALES SUPPORT

 AUS 1300 855 831

AUS Hotline Costs: Local rate for landline calls*
 *Charges may vary dependent upon network operator or mobile network provider.

 support@schepach.com.au

MODEL: Garden 5 in 1 Petrol Tool PRODUCT CODE: 58903 02/2018

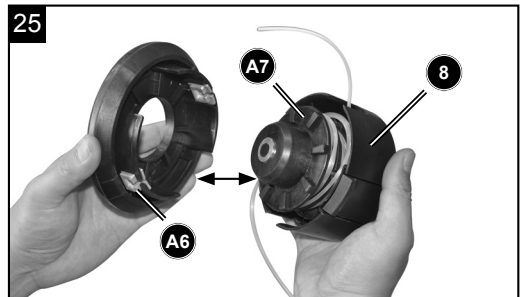
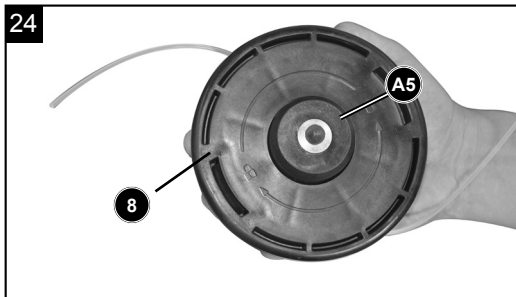
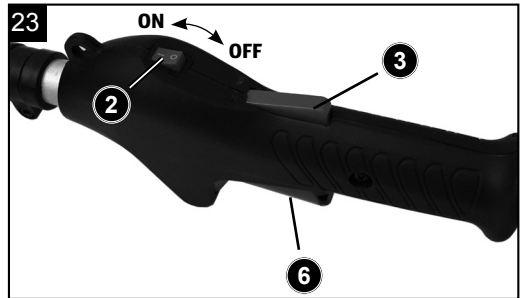
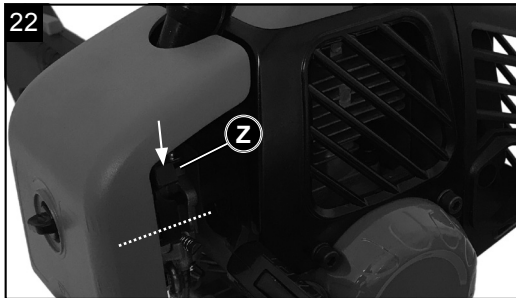
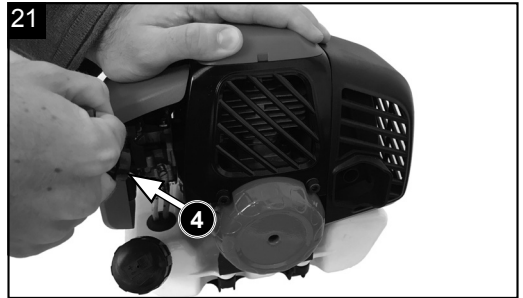
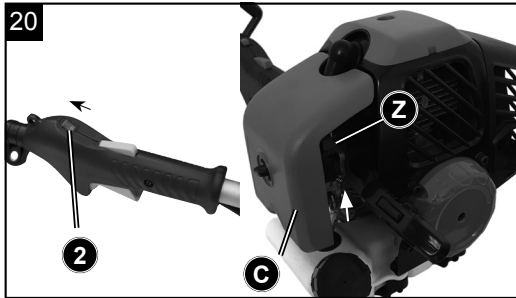
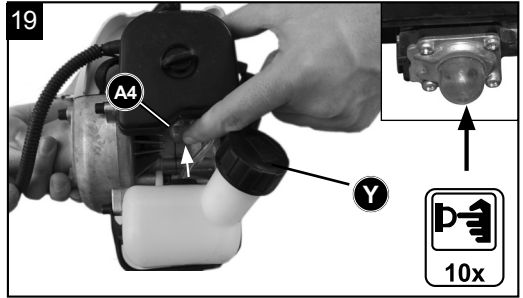
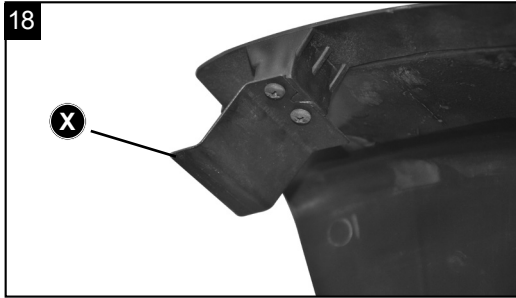

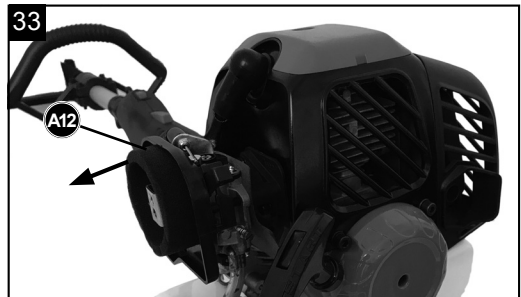
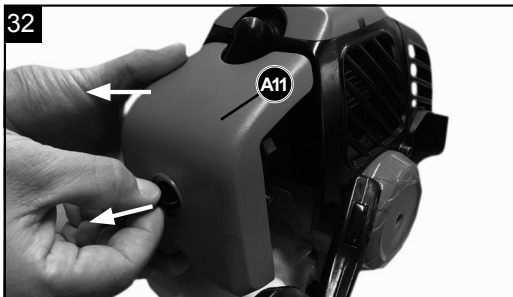
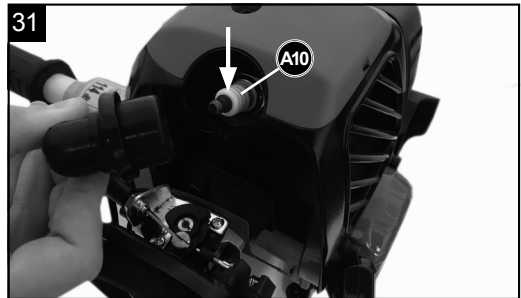
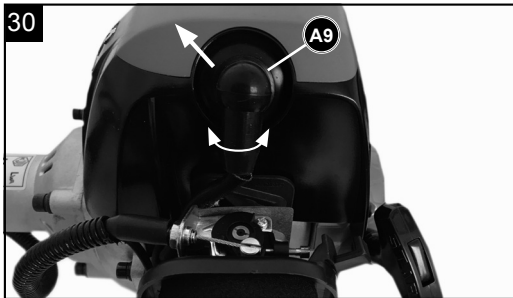
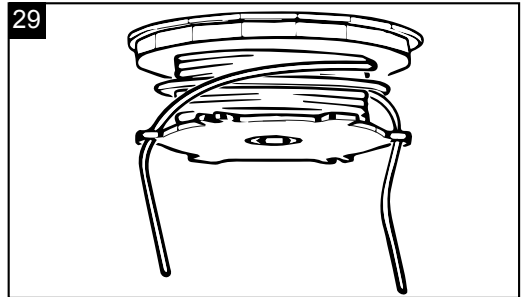
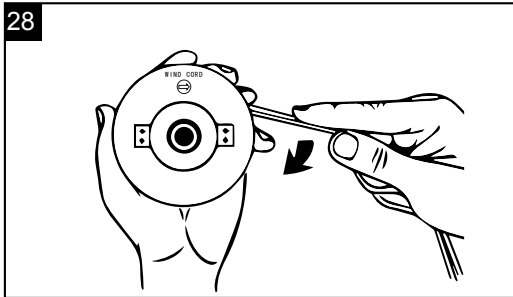
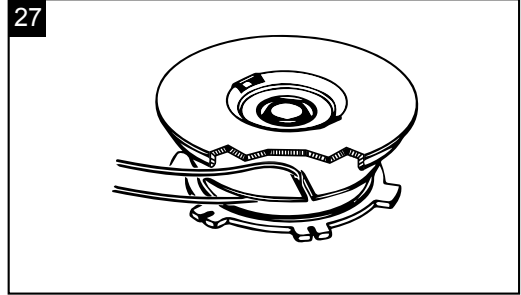
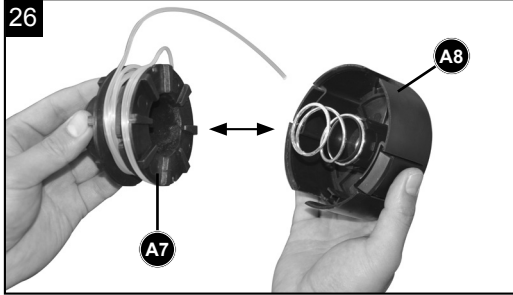

AFTER SALES SUPPORT

☎ AUS 1300 855 831

AUS Hotline Costs: Local rate for landline calls*
*Charges may vary dependent upon network operator or mobile network provider.

✉ support@scheppach.com.au

MODEL: Garden 5 in 1 Petrol Tool PRODUCT CODE: 58903 02/2018

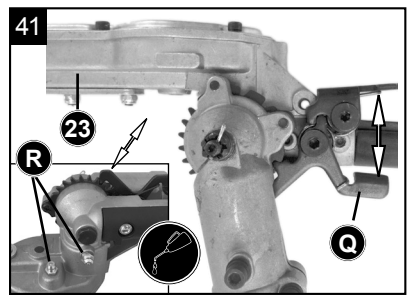
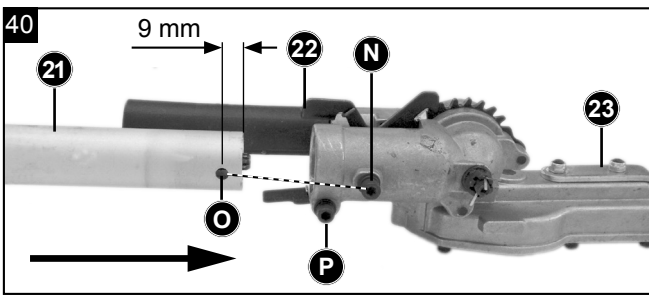
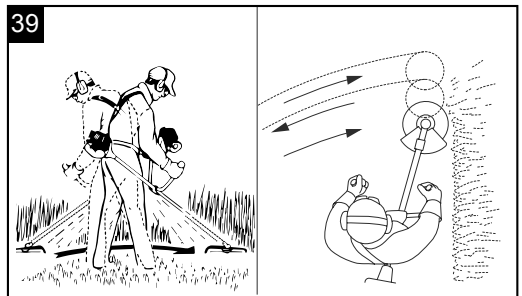
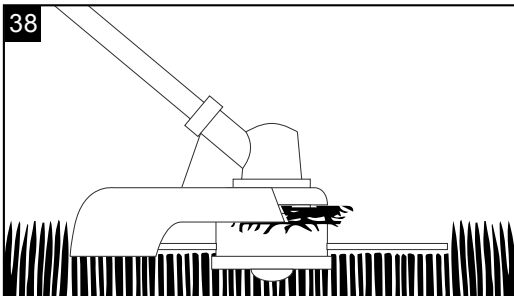
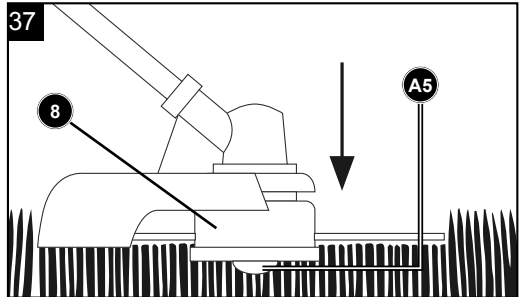
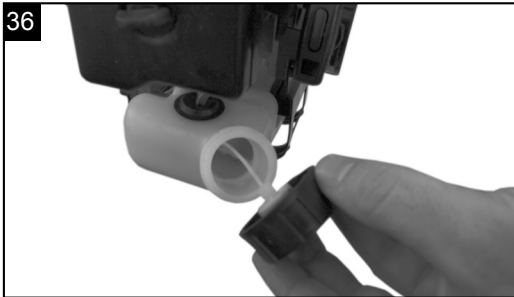
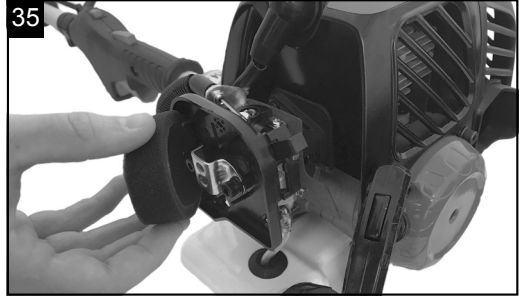
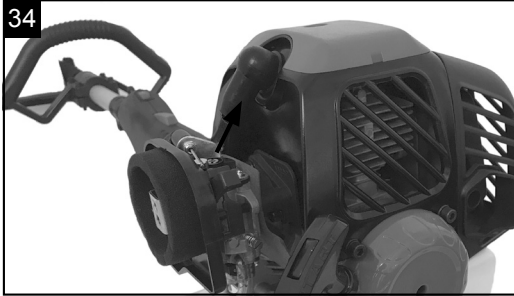

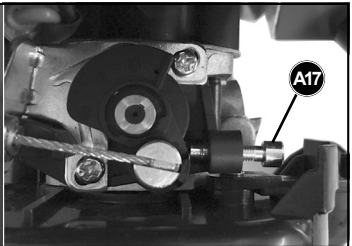
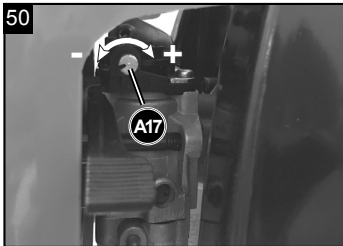
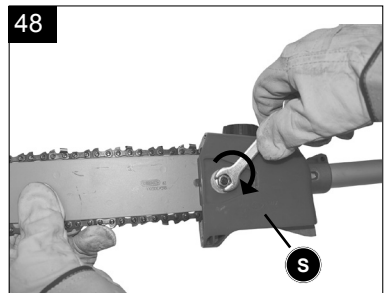
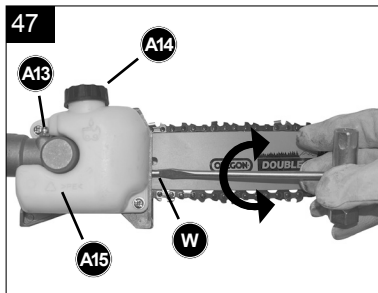
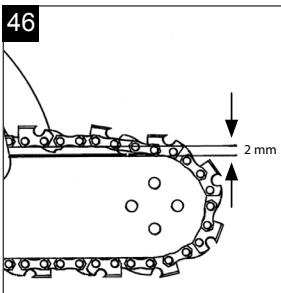
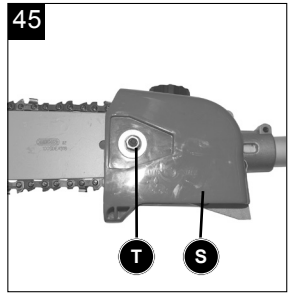
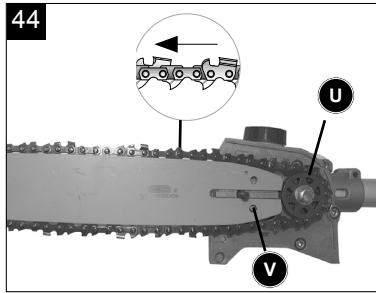
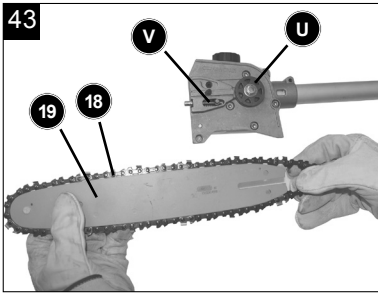
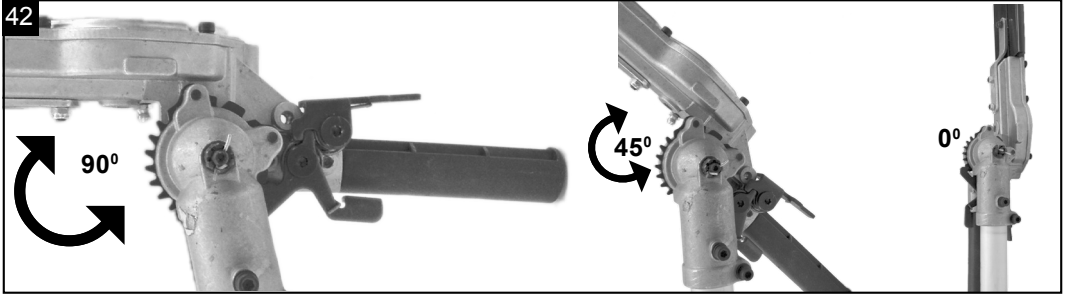

AFTER SALES SUPPORT

AUS 1300 855 831

AUS Hotline Costs: Local rate for landline calls*
 *Charges may vary dependent upon network operator or mobile network provider.

support@schepach.com.au

MODEL: Garden 5 in 1 Petrol Tool PRODUCT CODE: 58903 02/2018



GARDENLINE®
Garden 5 in 1 Petrol Tool



Warranty Details

REGISTER YOUR PURCHASE AT www.aldi.com.au/en/about-aldi/product-registration/ TO KEEP UP-TO-DATE WITH IMPORTANT PRODUCT INFORMATION

The product is guaranteed to be free from defects in workmanship and parts for a period of 36 months (dependant on product) from the date of purchase. Defects that occur within this warranty period, under normal use and care, will be repaired, replaced or refunded at our discretion. The benefits conferred by this warranty are in addition to all rights and remedies in respect of the product that the consumer has under the Competition and Consumer Act 2010 and similar state and territory laws.

Our goods come with guarantees that cannot be excluded under the Australian Consumer Law. You are entitled to a replacement or refund for a major failure and for compensation for any other reasonably foreseeable loss or damage. You are also entitled to have the goods repaired or replaced if the goods fail to be of acceptable quality and the failure does not amount to a major failure.

AFTER SALES SUPPORT

  1300 855 831

 support@schepach.com.au

AUS Hotline Costs: Local rate for landline calls*

MODEL: Garden 5 in 1 Petrol Tool Trimmer PRODUCT CODE: 58903 02/2018

*Charges may vary dependent upon network operator or mobile network provider.



Explanation of symbols



Read and observe operating instructions and safety instructions before commissioning!



Warning! Denotes risk of personal injury, loss of life, or damage to the tool in case of non-observance.



Warning! Keep all children, bystanders and helpers 15 meters away from the tool!



Wear protective helmet, ear and eye protection.



Warning! The exhaust and other parts of the engine will get very hot during use, do not touch!



Warning! Beware of thrown objects hit by cutting attachments. Never use without properly mounted blade guard.



Caution kickback!



Grass trimmer



Brush cutter



Petrol pump



Guaranteed sound power level



Warning! Petrol is very flammable. Avoid smoking or bringing any flame or sparks near petrol.



Do not expose the appliance to rain.

Explanation of symbols



Warning! Risk of injury!
Do not let your hands or feet come in contact with the blades when the motor is running.



Wear robust footwear and work gloves when using the device!



Caution, do not use saw blades or multi-part cutting tools made of metal!



Symbol for refuelling the "MIX PETROL" on Petrol reservoir cap.



Electric shock can cause fatal injury. Keep a distance of at least 10 m from power cables. Keep all children, bystanders and helpers 15 meters away from the tool!



Hedge trimmer
Pole saw



Direction of rotation left.
Grass trimmer / Brush cutter



Petrol reservoir capacity



The RCM Mark (Regulatory Compliance Mark) indicates that the product complies with the relevant guidelines of the ACMA as well as corresponding government requirements for the safety of electrical devices.



Edger Attachment



Warning! Beware of thrown objects hit by cutting attachments.



Never use without properly mounted blade guard.



Direction of rotation forward.
Edger Attachment



Warning! Keep all children, bystanders and helpers 15 meters away from the tool!

I. INTRODUCTION

Congratulations on choosing to buy a GARDENLINE® product.

All products brought to you by GARDENLINE® are manufactured to the highest standards of performance and safety, and as part of our philosophy of customer service and satisfaction, are backed by our comprehensive 3 Years Warranty.

We hope you will enjoy using your purchase for many years to come.

Note:

According to the applicable product liability law the manufacturer of this device is not liable for damages which arise on or in connection with this device in case of:

- improper handling,
- non-compliance with the instructions for use,
- repairs by third party, non-authorized skilled workers,
- installation and replacement of non-original spare parts,
- improper use.

Recommendations:

Read the entire text of the operating instructions prior to the assembly and operation of the device.

These operating instructions are intended to make it easier for you to get familiar with your device and utilise its intended possibilities of use.

The operating instructions contain important notes on how to work safely, properly and economically with your 5 in 1 Petrol Tool and how to avoid dangers, save repair costs, reduce downtime, and increase the reliability and working life of the 5 in 1 Petrol Tool.

In addition to the safety regulations contained herein, you must in any case comply with the applicable regulations of your country with respect to the operation of the 5 in 1 Petrol Tool.

Put the operating instructions in a clear plastic folder to protect them from dirt and humidity, and store them near the 5 in 1 Petrol Tool. The instructions must be read and carefully observed by each operator prior to starting the work. Only persons who have been trained in the use of the 5 in 1 Petrol Tool and have been informed on the related dangers and risks are allowed to use the 5 in 1 Petrol Tool. The required minimum age must be met. In addition to the safety notes contained in the present operating instructions and the special regulations of your country, the generally recognised technical rules for the operation of generators must be observed.

II. Layout (Fig. 1)

1. Front handle
2. ON / OFF switch
3. Throttle lever "Lock"
4. Recoil starter
5. Petrol reservoir
6. Throttle lever
7. Motor drive unit
8. Grass trimmer (Nylon cutting head)
9. Combined oil/petrol cylinder
10. Spark plug wrench
11. Open-ended spanner (8 mm / 10 mm)
12. Allen key (Size 5 mm)
13. Allen key (Size 4 mm)
14. Carrying Belt
15. Protection shield Chain saw blade
16. Pole saw
17. Automatic oil pump
18. Saw chain
19. Chain saw blade
20. Protection shield Hedge trimmer
21. Hedge trimmer
22. Adjustment lever
23. Cutting unit
24. Protection shield Brush cutter
25. Brush cutter
26. Protection shield (Brush cutter + Grass trimmer)
27. Cutting blade (Brush cutter)
28. Edger Attachment

III. Scope of delivery

- Open the packaging and take out the equipment with care.
- Remove the packaging material and any packaging and/or transportation braces (if available).
- Check to see if all items are present.
- Inspect the equipment and accessories for transport damage. In case of complaints the supplier is to be informed immediately. Complaints received at a later date will not be acknowledged.
- If possible, keep the packaging until the end of the guarantee period.

- Read the operating instructions to make yourself familiar with the device prior to using it.
- Only use original parts for accessories as well as for wearing and spare parts. Spare parts are available from your specialized dealer.
- Specify our part numbers as well as the type and year of construction of the device in your orders.

⚠ Important!

The equipment and packaging material are not toys. Do not let children play with plastic bags, foils or small parts. There is a danger of swallowing or suffocating!

IV. Intended use

The Brush cutter (using the Cutting blade) is designed for cutting young trees, strong weeds and undergrowth.

The Grass trimmer (using the Nylon cutting head) is designed for cutting lawns, grassed areas and small weeds.

The Hedge trimmer is suitable for cutting hedges, bushes and shrubs.

The Pole saw is designed for lopping off tree branches. It is not suitable for extensive sawing work, felling trees or sawing any materials other than wood.

The Edger Attachment is suitable for sharp-contoured edging of lawns. It will cut almost all types of grass, weeds and soft green plants.

The operating instructions as supplied by the manufacturer must be obeyed to ensure that the equipment is used properly. Any use which is not expressly permitted in the user manual may result in damage to the equipment and place the user in serious danger. Be sure to observe the restrictions in the safety instructions.

Please note that our equipment has not been designed for use in commercial, trade or industrial applications. Our warranty will be voided if the equipment is used in commercial, trade or industrial businesses or for equivalent purposes.

Important: Due to the high risk of bodily injury to the user, the 5 in 1 Petrol Tool must not be used to carry out the following work: to clean dirt and debris off walkways, or to chop up tree or hedge clippings. Similarly, the 5 in 1 Petrol Tool must not be used to level out high areas. For safety reasons, the 5 in 1 Petrol Tool must not be used as a drive unit for other work tools or toolkits of any kind.

The equipment is allowed to be used only for its prescribed purpose. Any other use is deemed to be a case of misuse. The user/operator and not the manufacturer will be liable for any damage or injuries of any kind resulting from such misuse.

Non-permitted users:

People who are not familiar with the user manual, children under the age of 16 and people under the influence of alcohol, drugs and medication, as well as those who are tired or ill.

V. General Safety Warnings**Safety instructions**

- During transport, always turn off the motor.
- Never carry or transport the 5 in 1 Petrol Tool with running cutting tools.
- Only ever carry the 5 in 1 Petrol Tool in work posture:
 - 5 in 1 Petrol Tool on your back, left hand on the Front handle and right hand on the operating lever (also applies to left-handed people), with the cutting tools lowered towards the ground.
- In order to prevent damage and injury, or petrol from leaking, secure the 5 in 1 Petrol Tool against tipping over when transporting it in vehicles. Check the Petrol reservoir for tightness. We recommend emptying the Petrol reservoir before transport.
- The Petrol reservoir must be emptied before shipment.
- Make sure that no persons or animals are close to the working area (minimum distance of 15 m).
- Grass being cut and thrown up may contain foreign objects such as stones. You are responsible for the safety in your working area, and you are liable for damages to persons or property.
- It is not permitted to either start or use the Brush cutter in the vicinity of persons or animals.
- Do not use the 5 in 1 Petrol Tool when you are tired or distracted, or your ability to react is impaired when you are under the influence of alcohol or medication. Inattentiveness may cause serious injuries.
- Use approved safety goggles. Use approved ear protection. Use high-quality safety gloves.
- Use high-quality skid-proof protective shoes with safety steel caps. Never operate the 5 in 1 Petrol Tool wearing sandals, or when barefoot.
- Always wear an approved safety helmet for working in a forest.
- Do not wear wide clothing or jewellery. Wear long trousers to protect your legs. Wear safety helmet for long hair. Loose clothing, jewellery, and long hair can get caught in the moving parts. Wear suitable and durable tight working clothes.
- Keep body parts and clothing away from the cutting tool when you start the engine, or keep it running.
- Make sure you are standing in a stable and secure position during work. Avoid moving backwards with the 5 in 1 Petrol Tool due to risk of stumbling.
- Avoid any unnatural posture.

- When the 5 in 1 Petrol Tool has been operate for long hours, it may cause a circulatory disorder due to vibration (Raynaud's disease). In this case, it is impossible to specify any length of operation, because it may differ from person to person. The following factors can have an influence on this phenomenon: Circulatory disorders in the hands of the operator, low outdoor temperatures, long hours of operation. Therefore, it is recommended to wear warm protective gloves, and to take breaks at regular intervals.
- The exhaust of internal combustion engines is poisonous and can lead to suffocation, among others. It is not allowed to operate the 5 in 1 Petrol Tool in closed or poorly ventilated rooms.
- Refill the petrol tank only outdoors, or in well-ventilated areas.
- Petrol and petrol vapors are highly flammable. Keep away from flammable materials and sources of ignition, such as ovens or stoves.
- Do not smoke while refuelling or operating the 5 in 1 Petrol Tool.
- Immediately wipe away spilled petrol.
- Start the 5 in 1 Petrol Tool only at a location far away from the place of refuelling.
- Always make sure that the cover of the Petrol reservoir is well closed. Look out for possible leakage.
- When the engine is running or the engine is hot, it is not allowed to open the cap of the Petrol reservoir or refill petrol.
- Open the cap of the Petrol reservoir slowly so that petrol vapor can escape.
- Make sure the handles are dry, clean, and free of petrol mixed with oil.
- Do not use the 5 in 1 Petrol Tool without exhaust pipe and when the exhaust pipe guard is not properly installed.
- Do not touch the exhaust pipe, there is a risk of burns.
- Only use the petrol recommended in the user manual. Keep petrol only in containers designed for it, and store it at a safe location.
- While cutting on a slope, always stand below the cutting tool.
- Always make sure no objects or other debris is collecting in the trimmer head, in the protective hood, or in the engine.
- Always switch off the 5 in 1 Petrol Tool before you put it down.
- Do not use any wire, or anything similar in the line spool.
- Only work during daylight, or when the area is illuminated well using lighting.
- Subject the 5 in 1 Petrol Tool to a visual inspection before each use.
- Check, if all screws and connecting parts are tightened.
- Always use both hands to hold the 5 in 1 Petrol Tool.
- Check the 5 in 1 Petrol Tool, and its components and guards for damages, or wear and tear before each use, and have it repaired, if necessary. Never make the devices for protection and safety inoperable. Do not use the 5 in 1 Petrol Tool, when damages or signs of wear become apparent.
- Keep the tools clean and fully functional to ensure better and safer work.
- Always maintain a safe distance between the 5 in 1 Petrol Tool and your body during work.

- Always switch off the 5 in 1 Petrol Tool when work will be interrupted or the location will be changed; wait until the cutting tools have completely stopped, and turn off the engine.
- Never leave the 5 in 1 Petrol Tool without supervision at the place of work. Store the 5 in 1 Petrol Tool at a safe place when work will be interrupted.
- Persons operating the 5 in 1 Petrol Tool must not be distracted, or one may lose control over the 5 in 1 Petrol Tool.
- Never use the 5 in 1 Petrol Tool during rain, in a humid or wet environment, and do not store it outdoors.
- Should the 5 in 1 Petrol Tool become wet, wait until it is completely dry before you use it again.
- Before starting work, it is recommended to check the objects to be cut for possible foreign objects and to remove them. When despite of this you encounter a foreign object during cutting, switch off the 5 in 1 Petrol Tool and remove this object.
- If the tool is jammed by a foreign object (stones, piles of grass), switch it off, and remove the object using a blunt item. Never use your fingers to remove jammed foreign objects, because this may cause serious injuries.
- Always keep the running 5 in 1 Petrol Tool away from your body.
- **Attention:** the cutting tool still runs for some time after the 5 in 1 Petrol Tool is switched off!
- Do not overload the engine, and do not use it for work the 5 in 1 Petrol Tool is not designed for.
- Always make sure the ventilation openings are free of dirt.
- Store the 5 in 1 Petrol Tool out of the reach of children.
- Store the 5 in 1 Petrol Tool at a safe and dry location.
- Check the engine for damages after impact, or other damages.
- Keep body parts and pieces of clothing away from the trimmer head when you start the engine, or keep it running.
- Always keep in mind that especially during trimming of lawn edges, gravel enclosures, and similar locations stone and dirt can be hurled away from the cutting line.
- Never cross roads or paths when the 5 in 1 Petrol Tool is switched on.
- Never cut against hard objects such as stone, etc. This way you avoid injuries, and damages to the 5 in 1 Petrol Tool.
- Never use the 5 in 1 Petrol Tool without the guards attached.
- Never use your hands to stop the cutting device.
- Always wait until it stops on its own.
- Hold and guide the trimmer head as close to the ground as possible.
- Only cut grass growing on the ground. Do not cut grass in cracks in walls, growing or on rocks, etc.
- Always make sure no objects, or other debris is collecting in the trimmer head, in the protective hood, or in the engine.
- Only use the 5 in 1 Petrol Tool, when the guard is attached.

- Always switch off the 5 in 1 Petrol Tool, before you put it down.
- Keep in mind that there is risk of injuries in the area of the cutting device intended to cut off the line.
- **CAUTION:** The cutting tool continues rotating for a few seconds after the engine is turned off.
- Put the 5 in 1 Petrol Tool down only after the cutting tool has completely stopped and the motor is turned off.
- When the cutting tool is damaged, it must be replaced at once.
- Always use the original line only. Never use a metal wire instead of the nylon line.
- 5 in 1 Petrol Tool and cutting tools must be properly inspected and serviced periodically. Damages must be repaired by a service center.
- Only use accessories recommended by the manufacturer.
- Have your 5 in 1 Petrol Tool serviced only by qualified personnel and by use of original spare parts only. This ensures that the 5 in 1 Petrol Tool will work safely in the future.
- Used Standards to reduce risks: EN ISO 11806-1: 2000; EN ISO 11680-1: 2011; EN ISO 10517: 2009 + A1: 2013; ISO 11789: 1999

Residual risks

- There will always be residual risks, even if you use this equipment according to instructions. The following hazards can occur in connection with the construction and design of this 5 in 1 Petrol Tool.
- Health hazards resulting from swinging of hand and arm if the equipment is used for an extended period and if it is not operated or maintained properly.
- Injuries and material damage caused by ejection of tool attachments which are unexpectedly thrown from the equipment because of sudden damage, wear and tear or improper attachment.
- **Warning!** This 5 in 1 Petrol Tool generates an electromagnetic field during operation. Under certain circumstances, this field can affect active or passive medical implants. In order to reduce the risk of severe or fatal injuries, we recommend that people with medical implants consult their doctor and the manufacturer of the medical implant before operating the 5 in 1 Petrol Tool.
- Use the gripping spikes for every cut as the starting point and always start the cut with the saw chain running. Make the cut in such a way that the saw does not get jammed in the wood.
- Pay particular attention to branches under tension.
- Always pull the 5 in 1 Petrol Tool out of the wood when the saw chain is running.
- Never work with the 5 in 1 Petrol Tool above shoulder height or with only one hand.
- Always stand away from the falling direction. Position yourself on a slope above the tree to be felled.
- Always stand sideways when carrying out sawing work on a tree which is located on a slope, never work from above or below.
- Always look out for the falling direction of the parts which are cut off.
- Never start the cut with the bar tip and never cut with the bar tip.

- Risk of kickback! There is always a risk of kickback when the bar tip touches the wood or other objects. This makes the chainsaw uncontrollable and it may be thrown towards the operator with great force.
- Do not use the 5 in 1 Petrol Tool as a lever to move objects.
- Always use the chain guard during transport and storage.
- Secure the 5 in 1 Petrol Tool during transport in order to prevent loss of petrol, damage or injury.
- Warning!
- Keep passers-by away from running equipment but never work by yourself.
- Keep within earshot of others in case you need help.
- Stop the engine immediately when someone approaches you.
- Make sure that the saw chain does not come in contact with foreign objects such as stones, fences, nails and similar. These objects could be ejected and injure the operator or passers-by or damage the saw chain.
- National specifications may restrict the use of the Pole saw.
- Do not use the 5 in 1 Petrol Tool within 10 metres of a position from which it can reach high-voltage cables.

Before working on the 5 in 1 Petrol Tool itself (e.g. transport, set-up, retooling, cleaning and maintenance), disconnect the spark plug cap!

VI. Technical data

Typ	Garden 5 in 1 Petrol Tool
Cutting data Grass trimmer	
Cutting circle diameter of line mm	430
Cutting line diameter mm	2 x 2.4
Cutting line length m	4
Maximum speed grass trimmer min ⁻¹	7000
Cutting data Brush cutter	
Cutting circle diameter of blade mm	255
Cutter balde thickness mm	1.4
Teeth quantity	3
Maximum speed Brush cutter min ⁻¹	8500
Cutting data Hedge trimmer	
Max. Cutting circle diameter mm	24
Angle adjustment	+90°/0°/-75° (165°)

Max. Cutting length mm	400
Max. cutting speed min ⁻¹	1870
Cutting data Pole saw	
Guide bar length mm	305
Cutting length mm	254
Guide bar type	Oregon 100SDEA318
Chain pitch	3/8" (9,525")
Saw chain type	91PJ040X
Chain gauge mm	1.27
Oil tank capacity cm ³	125
Cutting data Edger Combi tool	
Edger Blade Length mm	223
Edger Blade diameter mm	226
Edger Blade thickness mm	2.8
Maximum speed Edger Attachment min ⁻¹	7200
Power unit	
Displacement cm ³	32.6
Max. engine output kW	0.9
Idle speed min ⁻¹	3000 ± 300
Petrol reservoir capacity cm ³	900
Petrol mix ratio	40:1
Engine type	2-stroke engine, air-cooled
Weight grass trimmer kg	7.47
Weight Brush cutter kg	7.33
Weight Pole saw kg	7.15
Weight Hedge trimmer kg	7.67
Weight Edger Attachment kg	8,48



Subject to technical changes!

Information concerning noise emission measured according to relevant standards:

Sound pressure	$L_{PA} = 95,8 \text{ dB(A)}$
Sound power	$L_{WA} = 114 \text{ dB(A)}$
Uncertainty	$K_{PA} = 3 \text{ dB(A)}$

Wear ear-muffs.

AFTER SALES SUPPORT

  1300 855 831

AUS Hotline Costs: Local rate for landline calls*
*Charges may vary dependent upon network operator or mobile network provider.

 support@scheppach.com.au

MODEL: Garden 5 in 1 Petrol Tool PRODUCT CODE: 58903 02/2018

The impact of noise can cause damage to hearing.

Vibrations:

Grass trimmer: A_{hv} = Front 4,24 m/s² - Rear 4,59 m/s²

Brush cutter: A_{hv} = Front 3,78 m/s² - Rear 4,11 m/s²

Hedge trimmer: A_{hv} = Front 4,65 m/s² - Rear 3,68 m/s²

Pole saw: A_{hv} = Front 5,32 m/s² - Rear 5,14 m/s²

Edger Attachment: A_{hv} = Front 7,73 m/s² - Rear 6,55 m/s²

Uncertainty K_{PA} = 1.5 m/s²

Reduce noise generation and vibration to a minimum!

- Use only equipment that is in perfect condition.
- Maintain and clean the equipment regularly.
- Adopt your way of working to the equipment.
- Do not overload the equipment.
- Have the equipment checked if necessary.
- Switch off the equipment when not in use.
- Wear gloves.

Important safety instructions in this user manual are marked with sign: ⚠

VII. Before starting the equipment

Each time before use, check the following:

- That there are no leaks in the petrol system.
- That the equipment is in perfect condition and that the safety devices and cutting devices are complete.
- That all screws are securely fastened.
- That all moving parts move smoothly.

Petrol and oil

Recommended petrols

Use only a mixture of unleaded petrol (without ethanol) and special 2-stroke engine oil. Mix the petrol mixture as indicated in the petrol mixing table.

⚠ Do not use a petrol mixture which has been stored for longer than 90 days.

⚠ Never use 2-stroke oil with a recommended mixing ratio of 100:1.

The manufacturer's warranty will be voided in case of engine damage due to inadequate lubrication.

⚠ Only use containers designed and approved for the purpose to transport and store petrol.

Pour the correct quantities of petrol and 2-stroke oil into the mixing bottle (see scale

printed on the bottle). Then shake the bottle well.

Never use oil for 4-cycle engine or use water cooled 2-cycle engine. It can cause spark plug fouling exhaust part blocking or piston ring sticking.

Mixed petrols, which have been left unused for a period of one month or more, may clog the carburettor or result in the engine foiling to operate property. Put remaining petrol into an airtight container and keep it in the dark and cool room.

Petrol mixing table

Mixing procedure: 40 parts petrol to 1 part oil

Example:

1 L Petrol: 0.025 l 2-stroke oil

5 L Petrol: 0.125 l 2-stroke oil

Warning!

Take care of the emission of exhaust gases.

Always shut off engine before fuelling. Never add petrol to a machine with a running or hot engine. Take care of fire!

VIII. Attachment and operation

ASSEMBLY

When assembling this 5 in 1 Petrol Tool, please follow the instructions for assembly printed.

1. Assemble the Front handle (1) on the 5 in 1 Petrol Tool. (Fig. 2-3)

- Install the Front handle (1) as shown on the image 3.
- Make sure that you align the pin with the hole. Tighten the screws only loosely before you have the most comfortable working position set to the risers. The Front handle (1) should be aligned as in figures 2+3 shown, then tighten the screws (A).

2. Mounting the shaft (B). (Fig. 4)

- Pull out the locking pin (E) and press the lower part of the shaft (B) downward until the locking pin engages. The locking pin (E) is in the right position when it is fully seated in the bore (C).
- Lastly, tighten the knurled screw (D) securely.

3. Assemble the Protection shield (Brush cutter + Grass trimmer) (26). (Fig. 5-7)

- Fix the Protection shield (Brush cutter + Grass trimmer) (26) as shown in figures 5-7.

⚠ Warning! Never use the 5 in 1 Petrol Tool without the guard assembled!

4. Assemble and disassemble the Grass trimmer (Nylon cutting head) (8). (Fig. 8-9)

To Release the nut (J).

- Line up the two holes of inner flange (G) and shield (K), use one screw driver to hold the inner flange (G) as shown and turn the nut (J) clockwise, the nut will be released.

To Fit the Nylon cutting head.

- Remove cover cap (I). Still hold the inner flange (G) and outer flange (H), take the Nylon cutting head on the shaft and rotate counter-clockwise, the Nylon cutting head is fitted.

To Release the Nylon cutting head.

- Use screw driver to hold inner flange (G) and then rotate the Nylon cutting head clockwise, it will be released.

5. Assemble and disassemble the Cutting blade (Brush cutter) (27). (Fig. 10-12)

To Fit the Cutting blade (Brush cutter) (27).

- Take the outer flange (H) and cover cap (I) off after release the nut (J), then put the Cutting blade (Brush cutter) (27), outer flange (H), cover cap (I) and nut (J) according to priority as shown in picture. Please note the direction of rotation of the Cutting blade (Brush cutter) (27). Use screw driver to hold inner flange (G) and tighten nut (J) counter-clockwise, ensure the nut (J) is tightened enough.

To release the Cutting blade (Brush cutter) (27).

- Use screw driver to hold inner flange (G) and release nut (J), the Cutting blade (Brush cutter) (27) can be taken off.

⚠ Warning!

Please make sure the Cutting blade (Brush cutter) (27) has been assembled correctly before use!

Note: The packaging material is made of recyclable materials. Dispose of packaging materials in accordance with regulations.

6. Fit the Carrying Belt (14). (Fig. 13-17)

⚠ **Only use Grass trimmer (8) and Cutting blade (Brush cutter) (27) with the Carrying Belt (14).** Fit the tool to the belt at the beginning of each work session while the engine is running and cutting tool is not started. **Be careful - Do not start the cutting Tool!**

- Wear the Carrying Belt (14) as shown in figure 14.
- Adjust the strap length so that the snap hook (L) is about a hand's breadth below the right hip.
- Fit the 5 in 1 Petrol Tool at the snap hook (L).
- Balance the 5 in 1 Petrol Tool when the tool is switched off.
- When standing in a normal working posture, the cutting head should touch the ground

during normal working position.

- It is important that the Brush cutter (25) is always well balanced.
- For operation, hook the Motor drive unit (7) into the snap hook (L) of the Carrying Belt (14).
- **ATTENTION!** In an emergency, the safety latch (M) can be pulled from the harness. The 5 in 1 Petrol Tool then detaches immediately from the Carrying Belt (14) and falls to the ground. (Fig.17)
- Reattach in reverse order by snapping safety latch (M) into the harness.

7. Mounting of the Hedge trimmer (21) (Fig. 40-42)

Note: Drive shaft for Hedge trimmer not pre-assembled!

- Release screw (N) and loosen screw (P), align the holes (O) so that they are flush and reattach the screw (N) back in.
- Place the Hedge trimmer (21) precisely as shown in Figure 40 on the connecting rod.
- Re-tighten the screws (P+N).
- Adjust the slope by unlocking the lock (Q) (Fig. 41)
- The Hedge trimmer can be tilted from 0° to 90° (Fig.42).

8. Fitting the Chain saw blade (19) and the Saw chain (18) (Fig. 43-45)

⚠ Warning! Wear protective gloves.

- Remove the chain wheel cover (Fig. 45 Pos. S) by undoing the fastening nut (T). Lay the Saw chain (18) as shown into the groove which runs around the Chain saw blade (19).
- Please note the alignment of the Saw chain teeth (Fig. 44). Insert the Chain saw blade (19) as shown in Fig. 44 into the mount at the gear unit.
- Place the Saw chain (18) around the chain wheel (U). Make sure that the teeth of the Saw chain (18) engage securely in the chain wheel (U). The Chain saw blade (19) must be hooked into the chain tensioning bolt (V).
- Fit the chain wheel cover (S)

Important! Do not fully tighten the fastening nut (T) until after you have adjusted the chain tension (see section 8.1).

8.1 Tensioning the Saw chain (18) (Fig. 45-48)

Important! Always pull out the spark boot plug (A9) before performing any checks or adjustments.

- Undo the fastening nut (T) of the chain wheel cover (S) by a few turns (Fig. 45).
- Adjust the saw chain tension with the chain tensioning screw (Fig. 47 Pos. W). Turning the screw clockwise increases the saw chain tension, turning it counter-clockwise decreases the saw chain tension. The Saw chain (18) is correctly tensioned if it can be raised by around 2 mm in the middle of the Chain saw blade (19) (Fig. 46).
- Tighten the fastening nut (T) of the chain wheel cover (S) (Fig. 48).
- **Important!** All the saw chain links must lie properly in the guide groove of the Chain saw blade (19).

Notes on tensioning the Saw chain (18):

The Saw chain (18) must be properly tensioned to ensure safe operation. When the Saw chain (18) can be raised by around 2 mm in the Chain saw blade (19), you know that the saw chain tension is ideal. During cutting, the temperature of the Saw chain (18) rises and its length changes. It is important therefore to check the saw chain tension at least every 10 minutes and to adjust it again as required. This applies in particular to new saw chains. When you have finished working, slacken the Saw chain (18) again as it will shorten when it cools down. This will help to prevent damage to the Saw chain (18).

9. Assembling the Edger Attachment

Pull the protective caps off of the ends of the shaft and keep them in a safe place for later use.

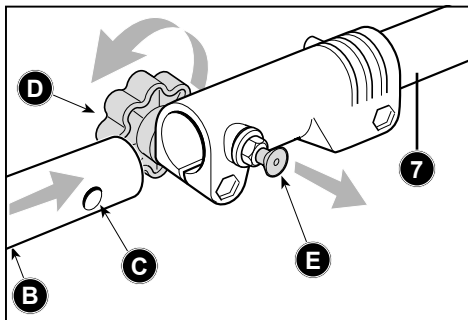
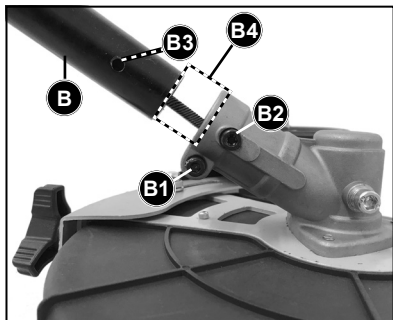
**9.1 Connecting drive tube to gearbox (B4)**

1. Loosen the 2 clamping screws (B1+B2) on the gearbox (B4) of the Edger attachment
Do not remove!
2. Insert curved end of drive tube (B) in the gearbox (B4), turn the gearbox (B4) back and forth as necessary.
3. Push the shaft in as far as it will go.
4. Align the gearbox on the shaft so that the screw (B2) is aligned with the hole (B3) in the shaft.
5. Tighten the clamping screws (B1+B2) firmly.
6. Pull out the locking pin (E) and press the lower part of the shaft (B) downward until the locking pin engages. The locking pin (E) is in the right position when it is fully seated in the bore (C).
7. Lastly, tighten the knurled screw (D) securely.

Reverse the above sequence to remove the drive tube.

9.1 Mounting the Cutting Blade / Edger Attachment

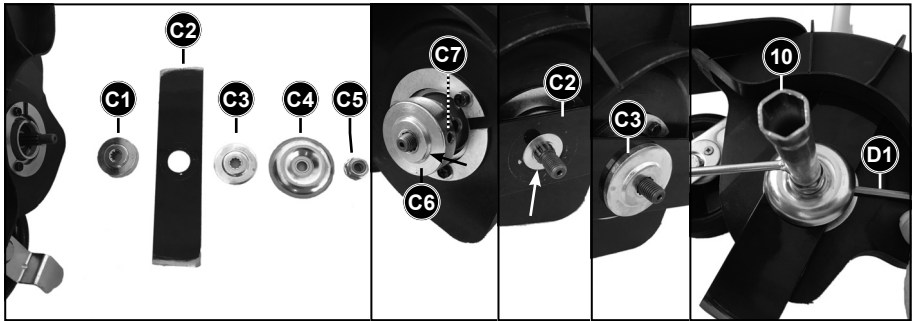

- Insert the Allen key (D1) as far as possible into the bore (C7), push lightly and rotate back and forth a little together with the inner flange (C1) until the shaft is blocked.
- Fit Spark plug wrench (10) onto nut (C5).
- Turn nut (C5) clockwise (left-hand thread) and remove it.
- Remove the outer flange (C3) and flange cover (C4).
- Position the cutting blade (C2) on the thrust plate (C6) at the inner flange (C1).
- ⚠ **Warning!** The collar (arrow) must engage the hole in the cutting blade.
- Fit the outer flange (C3) and flange cover (C4) on the shaft and block the shaft.
- Screw nut (C5) counter-clockwise onto shaft and tighten.

⚠ **Warning! Nut (C5) is self-locking. Always be sure that nut is fitted firmly!**

OPERATION

When working with the equipment as Grass trimmer and Brush cutter, the appropriate Protection shield (Brush cutter + Grass trimmer) (26) for Cutting blade mode or cutting line mode must be fitted to prevent objects being thrown out by the equipment.

Filling with petrol

⚠ **Danger of injury! Petrol is explosive!**

Turn the motor off and let the 5 in 1 Petrol Tool cool down.

Wear safety gloves.

Avoid contact with skin and eyes.

Make sure you observe the "General Safety Warnings" paragraph.

- Only ever refuel the 5 in 1 Petrol Tool outdoors or in sufficiently ventilated rooms.
- Clean around the filling area. Contaminants in the Petrol reservoir (5) will cause operating problems.

- Before refuelling, shake the container with the petrol mixture.
- Carefully open the petrol filler cap (Y) so that potential pressure can be release. (Fig. 19)
- Carefully pour in the petrol mixture to the lower edge of the filler.
- Close the petrol filler cap (Y). Ensure the petrol filler cap closes tightly.
- Clean the petrol filler cap and the area around it.
- Check the Petrol reservoir (5) and the petrol line for leaks.

Before starting the motor, remove yourself from the fuelling place by at least three metres.

Draining petrol. (Fig. 36)

Only ever empty the Petrol reservoir (5) outdoors or in well-ventilated rooms.

- Hold a collection container beneath the opening at the petrol filler pipe.
- Unscrew the petrol filler cap (Y) and remove it.
- Allow the petrol to run out completely.
- Screw the petrol filler cap (Y) on firmly by hand.

Start on the unit

Do not start the unit until it has been completely assembled.

⚠ Danger of injury!

Only start the 5 in 1 Petrol Tool if an attachment is connected! Remove the appropriate transportation protection and inspect the unit is in good working condition. Never use a damaged, poorly adjusted or serviced or not completely and securely assembled device.

Check before use!

- Check the safe condition of the device:
- Check the device for leaks.
- Check the device for visual defects.
- Check that all parts of the device have been securely fitted.
- Check that all safety devices are in proper condition.

Start (Fig. 17, 19-23)

Once the 5 in 1 Petrol Tool has been set up properly, start the engine as follow:

1. Turn the ON / OFF switch (2) to the "I" position. (Fig. 20)
2. Put the choke lever (Z) on the  position. (Fig. 20)
3. Press the petrol pump (A4) more than 5 times. (Fig. 19)
4. Pull the Recoil starter (4) 3-5 times to start the engine. (Fig. 21)

Never place feet on the shaft or kneel on it.

5. Once the motor is running, briefly wait, then put the choke lever (Z) into position . (Fig. 22)

If using the grass trimmer or brush cutter now attach 5 in 1 Petrol Tool to the safety harness.

6. To start the cutting tools, operate the Throttle lever "Lock" (3) with the palm of your hand, and the Throttle lever (6) with your fingers. The further you push the Throttle lever (6), the higher the motor speed. When releasing the Throttle lever (6), the motor becomes idle and the cutting tools stop. (Fig.23.) The cutting tools should not continue turning and should not move when the motor is idle.
7. If there are problems, immediately turn the ON / OFF switch (2) to "0" so the motor stops. **⚠ Caution! The cutting tools may continue turning for a few seconds.**
8. If any problem occurs, pull the safety latch (M), then release the Brush cutter immediately. (Fig. 17)
9. If the motor is warm, you can leave the choke lever (Z) in the "warm start and work" position .

Note: If the engine does not start up even after several attempts, read the section "Troubleshooting".

Note: Always pull the Recoil starter (4) out in a straight line. If it is pulled out at an angle, then friction will occur on the eyelet. As a result of this friction, the cable will become frayed and will wear away faster. Always hold the Recoil starter handle when the cable retracts. **Never allow the cable to snap back when it has been pulled out.**

Note: Do not start the motor in tall grass.

⚠ Attention: When the engine has been switched off, the cutting unit continues running for several seconds therefore do not touch the cutting unit until it has come to a standstill!

IX. Working instructions

Working with Brush cutter / Grass trimmer

- When you work with the Brush cutter for the first time, familiarize yourself with the operation and control of the 5 in 1 Petrol Tool without running engine.
- The design of the Brush cutter allows for operation only at the right side of the user's body.
- Keep the Brush cutter firmly with both hands on the handles.
- Always make sure that the cutting tool continues to rotate briefly after the throttle has been released.
- Be aware that the cutting tool does not rotate when idling and throttle is not actuated.
- Always work with high speed so you have the best cutting results.
- If the cutter hits a stone or a tree when working, turn off the engine and remove the spark plug then examine the Brush cutter for damage.
- **Caution:** Always be extra careful when working in difficult terrain and slopes. Cut tall grass gradually so as not to overload the unit.

- Always wear safety glasses and hearing protection and a safety helmet.

Caution: Be especially careful, when using this working technique, because the further away the cutting tool is from the ground, the higher is the risk that objects to be cut and particles will be hurled sideways.

Mowing with Grass trimmer (Fig. 39)

- Use the grass trimmer for a clean cut when trimming uneven edges, or around fencing posts or the base of trees.
 - Carefully advance the trimming line to an obstacle, and use the tip of the line to cut around the obstacle. When the trimming line comes into contact with stones, trees, and walls, the line wears out or breaks off ahead of time.
 - Swing the 5 in 1 Petrol Tool like a normal scythe horizontally from right to left and back again. You define the cutting height depending on how high you are holding the 5 in 1 Petrol Tool.
- ⚠ Never replace the nylon line with a metal wire. **RISK OF INJURIES**

Automatic thread trimming (Fig. 18)

The 5 in 1 Petrol Tool is delivered with a filled nylon line cassette.

This line will wear out during work. To feed new line, forcefully press the head of the line cassette onto the ground while the engine is running at working speed.

The line is automatically fed due to centrifugal force.

The integrated blade (X) at the Protection shield (Brush cutter + Grass trimmer) (26) will shorten the trimming line to the correct length.

Run the trim line approach cautiously to an obstacle and cut with the tip of the line around the obstacle.

Mowing with Brush cutter

Use the Cutting blade (Brush cutter) (27) to comb through brushwood, rank growth, young tree populations (trunk diameter of maximum 2 cm), and high grass.

- While using metal cutting tools, there is generally a risk of recoil, when the tool hits a solid obstacle (stones, trees, branches, etc.). Thereby, the tool is hurled backwards against the rotating direction.
- To cut rank growth and brushwood, you "immerse" the Cutting blade from the top.

Angle adjustment / Hedge trimmer (21)

By swivelling the Cutting unit (23), the Hedge trimmer (21) can be adjusted to the working conditions from 0° to 90°. (Fig. 42)

- Warning! Adjust the angle only when the motor has been turned off.
 - Push both levers down and put the cutter head in the required position. (Fig. 41)
 - Release both levers until they click into place in the notch.
 - Before use, check that the adjustment levers have clicked into place properly. (Fig. 42)
- Oil the blades and the angle adjustment each time before starting work, with environ-

mentally friendly lubricant.

Regularly oil the blades during working hours as well.

⚠ **Warning!** Oil the 5 in 1 Petrol Tool only when the motor has been turned off.

CAUTION: Incorrect use and misuse can damage the Brush cutter and cause severe injuries because of pieces hurled away.

To minimize the risk of accidents by use of the Cutting blade, take note of following points:

- Never cut shrubbery or wood whose diameter is larger than 2 cm.
- Avoid contact with metal bodies, stones, etc.
- Periodically check the Cutting blade for damages. Never continue to use a damaged Cutting blade.
- When the Cutting blade becomes apparently blunt, it must be sharpened according to instructions. When the Cutting blade is apparently out of balance, it must be replaced.

Working with Pole saw

Oiling of Saw chain (18) and Chain saw blade (19)

It is recommended to use commercial saw chain oil.

Remove the oil tank cap. (Fig. 47 Pos. A14)

Fill the chain saw oil tank (Fig.47 Pos. A15) to 80% with chain saw oil.

Close Oil tank cap (Fig.47 Pos. A14)

Oil Supply Control

Always make sure the automatic oiler system is working properly. Keep the oil tank filled with Chain, Bar and Sprocket Oil.

Adequate lubrication of the bar and chain during cutting operations is essential to minimize friction with the guide bar.

Never starve the bar and chain of lubricating oil. Running the saw dry or with too little oil will decrease cutting efficiency, shorten saw chain life, cause rapid dulling of chain, and lead to excessive wear of bar from overheating. Too little oil is evidenced by smoke or bar discolouration.

To check the saw chain lubrication, hold the chain saw with the saw chain over a piece of paper and give a few seconds of full throttle.

The oil quantity can be checked on the paper. The chain must always be thrown off a small amount of oil. After a few seconds, a light oil trail must be visible.

Automatic oiler system / Fine adjustment (Fig 49).

Use screw (A16) to reduce or increase the amount of oil.

Clockwise - oil quantity is reduced (-)

Counter-clockwise - oil quantity increases (+)

Precautions for Pole saw procedure

Never stand under the branch you want to saw. Use special caution when working with branches under tension and splintering wood. Possible risk of injury caused by falling branches and catapulting pieces of wood. In general, it is recommended to set the Pole saw at an angle of 60 ° to the ground.

During the cutting operation hold the unit firmly with both hands, ensure a safe stance and retain your balance.

- Never try to use your 5 in 1 Petrol Tool with one hand. The loss of control of your 5 in 1 Petrol Tool can cause serious injury or death. Never work on a ladder, a tree branch or other unstable surfaces.
- Never cut with the upper edge or the tip of the cutter bar.
- Make sure that the saw chain tension is always correctly adjusted.
- Practice for guiding the device with slight pressure, but you do not overload the motor.

Clear the work area before cutting interfering branches and undergrowth. Then you create a retreat area, far from the spot where the cut branches will fall, and remove any obstacles there. Keep the work area clean, remove the cut branches immediately. Pay attention to your point, wind direction and the possible direction of fall of the branches. Be prepared that fallen branches can strike back. Place all other tools and equipment at a safe distance from the branches to be cut, but not in the retreat area.

Always observe the condition of the tree.

Look for rot and decay in the roots and branches. If they are rotten inside, they can break off and fall down unexpectedly during cutting. Fractured and dead branches could also break off and fall down if shaking. For very thick or heavy branches you first make a small incision below the branch before you work from the top down to avoid chipping.

Basic cutting technique

Heavy branches break off easily when sawing. They tear long strips of bark away from the trunk, which damages the tree sustainably. The following technique can significantly

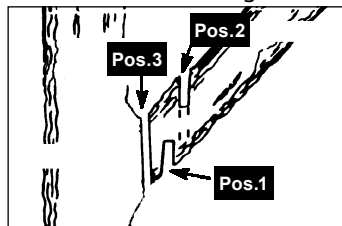

reduce this risk:

- The first incision on the branch should be 10 cm from the trunk (Pos.1).
- Second incision on the branch should be 15 cm from the trunk (Pos.2).
- Finally saw on top (Pos.3) until the branch breaks. Thus can be prevent a violation of the trunk.
- Then, remove with a clean cut from the top of the branch along the remaining.
- To keep, the damage to the tree is kept as low as possible, we recommend the interface additionally to seal with grafting wax.

Hazards by reactive forces

Reactive forces occur during operation of the saw chain. The forces which are applied to the wood are against the operator. They occur when the moving chain comes into contact with a fixed object such as a branch or is pinched. These forces can lead to a loss of control and injury. Understanding the origin of these forces can help you to avoid the scare and the loss of control. This saw is designed to ensure the return effects are not as noticeable as with traditional chainsaws.

Always still keep a firm grip and a good level to maintain control of the 5 in 1 Petrol Tool. The most common effects are:

- Setback,
- Recoil,
- Retreat

Kickback

Kickback may occur when the nose or tip of the guide bar touches an object, or when the wood closes in and pinches the saw chain in the cut. Tip contact in some cases may cause a lightning fast reverse reaction, kicking the guide bar up and back towards the operator. Pinching the saw chain along the top of the guide bar may push the guide bar rapidly back towards the operator. Either of these reactions may cause you to lose control of the saw which could result in serious personal injury.

Avoid kickback

The best protection is to avoid situations that lead to setbacks.

1. Keep the position of the upper guide rail always in mind.
2. Be especially careful when cutting in affected areas.

Be especially careful near wire fences and cutting small, hard knots, in which the chain can easily pinch.

3. Cut only one branch at a time.

Withdrawal

The withdrawal occurs when the chain on the underside of the bar suddenly sticks because it is jammed or encounters a foreign object in the wood. The chain then pulls the saw forward. The withdrawal often happens when the chain is not running at full speed when in contact with the wood.

Avoid withdrawal

Be aware of the forces and situations that can lead to jamming of the chain on the underside of the Chain saw blade.

Always start with running at full speed chain to cut.

Recoil

The recoil occurs when the chain on the top rail suddenly sticks because it is jammed or encounters a foreign object in the wood. The saw can suddenly strike in the direction of the operator. Rebounds happen often if the top rail is used for cutting.

Avoid recoil

Be aware of the forces and situations that can lead to jamming of the chain on top of rail. Do not cut more than one branch at a time.

Do not tilt the rail to the side when pulling out of cutting gap - the chain could get caught.

Working with Edger Attachment

An arrow on the deflector shows the correct direction of rotation of the cutting blade. The arrow on the deflector must always face away from you, so that cuttings and other debris will be diverted away from the machine and your position.

Adjust carrying harness and grip to suit your size before starting work. The machine should be properly balanced as specified in your instruction manual for proper control and less fatigue in operation. To be better prepared in case of an emergency, practise releasing the unit from the harness as quickly as possible.

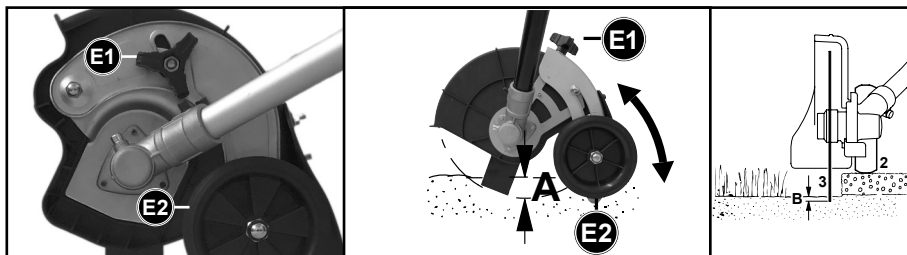

Adjust the depth of cut

- Shut off the engine - Risk of accident!
- Loosen wingnut (E1) counter-clockwise
- Adjust wheel (E2):
 - upwards - depth of cut (A) increases
 - downwards - depth of cut (A) decreases

The depth of cut is influenced by uneven ground as well as height and working position of the operator. For this reason,

- adjust the wheel (E2) so that the blade barely touches the ground when the machine is held in a normal working posture or penetrates the ground at most to a depth (B) of 5 mm.

- Tighten wingnut (E1) clockwise
- Standing in the normal working position, check the depth of cut again - correct it if necessary

⚠ **Warning!** Do not adjust the deflector.

The deflector has been set by the manufacturer so that the arrow on the deflector and the open side point away from the operator. This ensures that cuttings and other debris will be directed away from the machine and operator.

Edging

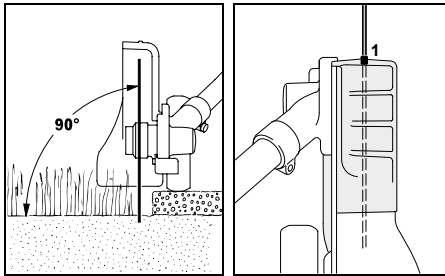

- Start the engine
- Start the cut at least half throttle and continue cutting at full throttle
- Hold and guide the unit so that the blade is vertical
- Cut steadily so that the engine speed does not decline to any major extent - do not apply force
- Cut at a normal walking pace
- Do not push the blade into the ground
- Always walk forwards when cutting, do not pull the unit towards you
- Cut at a steady pace - this avoids having to make several passes
- Use the gunning sight (1) for the cutting blade to align the blade to the edge

Replacing the cutting blade / Edger Attachment

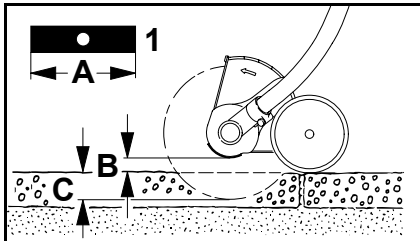

Do not attempt to straighten or weld a bent or cracked blade - it may break - it must be replaced

Replace the blade (1) if its length (A) is no longer sufficient to maintain the necessary ground clearance (B) and obtain the required depth of cut (C)

X. Maintenance

INJURY WARNING: Always wear protective gloves when working on or around cutting tools.

Before performing any maintenance or cleaning work, always turn off the engine and pull out the spark boot plug.

1. Do not spray the unit with water. It damages the engine.
2. Clean the unit with a cloth, hand brush, etc.
3. Use a moist piece of cloth to clean the plastic parts. Do not use any cleaning agents, solvents, or sharp objects.
4. During the course of work, wet grass and weed wraps around the drive shaft below the cutting guard for technical reasons. Remove this, otherwise the engine will overheat because of too much friction. (Fig. 38)

Regular checks

Keep in mind that following specifications relate to normal usage. Owing to circumstances (longer periods of daily work, severe dust exposure, etc.), the specified intervals will become correspondingly shorter.

Before starting work, after tank filling, after impact or dropping:

- Check the cutting tools for secure seating, general visual check for cracks and damage.
- Immediately replace damaged or blunt cutting tools, even in the event of minor hair-line cracks.
- Sharpen cutting tools (also when required).

Weekly inspection:

- Lubrication of gear (also, if necessary).

If necessary:

- Re-tighten accessible fastening screws and nuts. You will avoid excessive wear and tear and damages of the 5 in 1 Petrol Tool, when you follow the instructions in this user manual.

Replacing the line spool/cutting line (Fig. 24-29)

1. Pull off the line guard cap (A6) from the line spool (A7) by forcefully pressing between the retaining plates of the line spool housing (A8).
2. Remove the line spool (A7) with line remaining and the compression spring.
3. Remove the used up spool.
4. Take the new line spool and pull out 10 cm at both lines each.
5. Now, place the line spool (A7) on the tapered spring, and guide both lines each through the round metal lugs at the line guard cap (A6).

6. Then place the line guard cap (A6) on the new line spool (A7). Turn it so that the plates of the line guard cap (A6) are pushed with the springs in the line spool housing (A8).
7. Now, press the line guard cap (A6) together with the line spool (A7), until it engages in the line spool housing (A8).
8. The integrated blade (X) in the Protection shield (Brush cutter + Grass trimmer) (26) shortens the trimming line to the correct length, when the engine starts again.

Grinding the integrated blade (X) in the Protection shield (Brush cutter + Grass trimmer) (26)

The integrated blade (X) in the Protection shield (Brush cutter + Grass trimmer) (26) can become blunt over time.

- When you notice this, undo the screws holding the cutting blade (X) on the Protection shield.
- Clamp the cutting blade (X) in a vise.
- Sharpen the cutting blade (X) with a flat file and make sure that the angle of the cutting edge is not altered in the process. File in one direction only.
- **Important!** Reassemble the cutting blade (X).

Replacing and resharpening the cutting blade (X) at the end of the mowing season always resharpen the cutting blade (X) or, if required, replace the cutting blade (X) with a new one.

Grinding Cutting blade (Brush cutter) (27)

If the Cutting blade (Brush cutter) (27) is only slightly dull, they can re-sharpen themselves.

- Clamp the Cutting blade (Brush cutter) (27) in a vise.
- Sharpen the Cutting blade (Brush cutter) (27) with a flat file and make sure that the angle of the cutting edge is not altered in the process. (~25°) File in one direction only.
- Replace the Cutting blade (Brush cutter) (27) at the latest after five times sharpening.

Replace the blade with heavy wear or broken blade.

Unbalanced blades will cause the brush cutter to vibrate violently-risk of accident!

Lubricate angle transmission / Pole saw

Lubricate with lithium-based grease. Use screw (R) and put in the grease, turning the shaft manually until grease emerges.

Change and clean the spark plug (A10) (Fig. 30-31)

Check the spark plug air gap at least once a year or when the engine starts poorly. The correct gap between ignition flag and ignition contact is 0.25"/0.63 mm.

- Wait until the engine has cooled down completely.
- Pull the spark boot plug (A9) out off the spark plug (A10), and use the supplied spark plug wrench (10) to remove the spark plug by turning.

- When the electrode is severely worn out or reveals a strong incrustation, the spark plug (A10) must be replaced with an equivalent plug.
- A strong incrustation of the spark plug (A10) can be caused by: Amount of oil is too high in the petrol mix, poor oil quality, old petrol mix, or plugged up air filter.
- Screw the spark plug (A10) by hand completely into the thread. (Avoid jamming it)
- Use the supplied spark plug wrench (10) to tighten the spark plug (A10).
- When using a torque wrench, the tightening torque is 12-15 Nm.
- Plug the spark boot plug (A9) correctly on the spark plug (A10).

Clean the air filter (Fig. 32-35)

Soiled air filters reduce the engine power by supplying too little air to the carburettor. Dust and pollen plug up the pores of the filter made of foamed plastic. Regular checks are therefore essential.

- Disassemble the air filter cover (A11) by turning the fitting screw counter-clockwise and remove the sponge filter element (A12).
- To avoid objects falling into the air tank, replace the air filter cover (A11).
- Wash the filter element in warm soap water, rinse and allow drying naturally.

Important: Never clean the air filter with petrol or inflammable solvents.

In order not to shorten the service life of the engine, a damaged air filter must be replaced at once.

- Install the sponge filter element (A12) in reverse order.

⚠ Warning!

Never run the engine without the air filter element installed.

Care of the guide rail

Turn the rail around every time you have the saw chain sharpened or replaced. This will avoid a one-sided wear of the rail, especially at the top and bottom.

Regularly clean

1 = the opening for the oil supply

2 = the oil passage

3 = the raceway groove of the rail

Servicing and sharpening of saw chain

Working effectively with the chain saw is only possible if the saw chain is sharp and in good condition. This also reduces the risk of kickback. The saw chain can be re-sharpened by any dealer. Do not attempt to sharpen the saw chain yourself unless you have the necessary special tools and experience. A properly sharpened saw chain goes way through the wood and it requires very little pressure. Do not work with a dull or damaged saw chain. It increases physical exertion, increase the vibrations and leads to unsatisfactory results and higher wear.

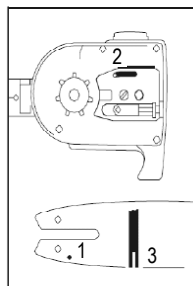

- Clean the saw chain.
- Check it.
- Replace damaged or worn parts with matching spare parts they are in the shape and size of the original parts as necessary.
- Sharpening a saw chain should be performed only by experienced users!
- Notice. Below the angle and dimensions
If the saw chain is not properly sharpened or the depth is too small, there is a higher risk of reversion effects and resulting injuries! The saw chain cannot be fixed on the guide rail. It is therefore best to remove the saw chain from the rail and then sharpen.
- Select the appropriate tools for the chain pitch sharpening tool.

The chain pitch (for example 3/8 ") is highlighted in the depth of each blade.

Use only special files for chainsaws! Other files have the wrong shape and the wrong cut. Select the file according to the diameter of your chain pitch.

Make sure to observe the following angle when sharpening the saw chain.

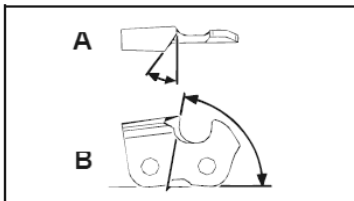

A = filing angle

B = the angle of the side plate

The angle must also be maintained for all knives.

If angles (A+B) are not the same for all saw chain teeth, the chain will run irregularly, wear quickly and break down prematurely.

In order to meet these requirements sufficiently and regularly:

- A File Holder must be used when sharpening the saw chain by hand. The correct filing-angle is marked on it.
- Hold the file horizontally (at a right angle to the guide rail) and file according to the angle mark on the file holder. Support the file holder on the top plate and depth gauge.
- File down. The knife is always from the inside to the outside
- The file sharpens only in forward motion. Lift it off in the backward motion.
- Do not touch the dynamic links with the file.
- Turn the file regularly continue to avoid a one-sided wear.
- Use new saw chain if working in hard wood, bones raw edges.

All knives must have the same length, otherwise they will also vary.

As a result, the chain is irregular and it increases the risk of going broke.

Check the Hedge trimmer for obvious faults such as:

- Loose attachments
- Worn or damaged components
- Bent, broken or damaged cutting tools
- Correctly attached and working covers and safety devices

- Untypical noises of the cutting tools

Immediately replace damaged or blunt cutting tools, even in the event of minor damage.

Oiling the chain wheel / Pole saw (Fig. 47)

Oil the gear unit every 10 to 20 operating hours.

- 1 Position the grease gun at the lubricating nipples (A13).
- 2 Insert some grease.

Oil the cutting tools and the angle adjustment with environmentally friendly lubricant.

Adjusting the idle speed (Fig. 50)

If the cutting device runs idle, correct the idle speed.

1. Allow the engine to warm for 3-5 minutes (No high speeds!).
2. Turn the adjusting screw (A17):
clockwise - idle speed increases (+)
counter-clockwise - Idle speed decreases (-)

The idle speed is $3000 \pm 200 \text{ min}^{-1}$

Contact the manufacturer if the cutter continues to run at idle.

Do not continue to operate the unit!

The user is responsible for all damages caused by non-compliance with instructions in this user manual. This also applies to non-authorized modifications of the 5 in 1 Petrol Tool, use of non-authorized spare parts, accessories, working tools, unrelated and not intended use, secondary damages due to use of faulty components.

Wear Parts

Even when used in the intended way, some components are subject to normal wear. They have to be replaced depending on the kind of duration of usage. These parts include, among others, the cutting tool and the retaining disk.

⚠ Warning! Use only original manufacturer's replacement parts, accessories and attachments. Failure to do so can cause poor performance, possible injury and may void your warranty

Important hint in case of sending the equipment to a service station:

Due to security reasons please see to it that the equipment is sent back free of oil and petrol!

Ordering replacement parts

Please quote the following data when ordering replacement parts:

- Type of machine
- Article number of the 5 in 1 Petrol Tool

Replacement parts / Accessories:

For the cutting equipment listed here, you can always use the safety guards provided with the unit.

Grass trimmer/Brush cutter:

Spool with Ø 430	7910700701
Blade with 3 teeth Ø 255 x 1.4	7910700702
Transport guard for blade 3 teeth	3904801065
Blade with 4 teeth Ø 255 x 1.5	7910700705
Transport guard for blade 4 teeth	3904801066
Blade with 8 teeth Ø 255 x 1.5	7910700711
Transport guard for blade 8 teeth	3904801066
Safety shield for grass trimmer	3904803034

Pole saw:

Saw chain Oregon 91PJ040X	7910700704
Guide rail Oregon 100SDEA318	3904801037
Transport guard for chain	3904801039
Extension for pole pruner	7910700710

Hedge trimmer:

Blade for Hedge trimmer 400 mm	7910700703
Transport guard for blade	3904801043

XI. Cleaning / Storage / Transport

Cleaning

- Keep handles free of oil, so you always have a secure hold.
- Clean the equipment as required with a damp cloth and, if necessary, mild washing up liquid.

⚠ Important!

- Always pull out the spark boot plug each time before carrying out any cleaning.
- Never immerse the equipment in water or other liquids in order to clean it.
- Store the 5 in 1 Petrol Tool in a safe and dry place out of the reach of children.

Storage

⚠ **Important!** Never put the equipment into storage for longer than 30 days without carrying out the following steps.

Storing the equipment

If you intend to store the equipment for longer than 30 days, the equipment must be prepared accordingly. Otherwise the petrol still remaining in the carburettor will evaporate and leave a rubbery sediment. This can cause problems when starting up the equipment and may require expensive repairs.

- 1 Slowly remove the Petrol reservoir cap to release any pressure that may have formed in the tank. Carefully empty the tank.
- 2 To remove the petrol from the carburettor, start the engine and let it run until the equipment stops.
- 3 Leave the engine to cool (approx. 5 minutes).
- 4 Remove the spark plug (see section 10 "Change and clean the spark plug").
- 5 Add one teaspoon of 2-stroke engine oil into the combustion chamber. Slowly pull the starter cord several times to apply a layer of oil to all internal components. Fit the spark plug again.

Note: Store the equipment in a dry place and far away from possible ignition sources such as an oven, a gas-fired hot water boiler, a gas-fired dryer, etc.

Putting the equipment back into operation

- 1 Remove the spark plug (see section 10 "Change and clean the spark plug").
- 2 Quickly tug on the starter cord to remove excess oil from the combustion chamber.
- 3 Clean the spark plug and check that the electrode gap is correct, or insert a new spark plug with the correct electrode gap.
- 4 Prepare the equipment for operation.
- 5 Fill the tank with the relevant mixture of petrol and oil. See the section "Petrol and oil".

Transport

⚠ Warning!

To reduce the risk of injury from loss of control and blade contact, never carry or transport your 5 in 1 Petrol Tool with the cutting attachment moving. Always switch off the engine and make sure the cutting blade has stopped before putting a 5 in 1 Petrol Tool down.

It may be carried only in a horizontal position. Grip the shaft in a manner that the machine is balanced horizontally. Keep the hot muffler away from your body and the cutting attachment behind you.

To transport the 5 in 1 Petrol Tool by car, empty the Petrol reservoir as described in section 8 "Draining petrol". Clean coarse dirt off the equipment with a brush or hand brush. When transporting in a vehicle, properly secure it to prevent turnover, fuel spillage and damage to the unit.

XII. Disposal and recycling

The equipment is supplied in packaging to prevent it from being damaged in transit. The raw materials in this packaging can be reused or recycled. The equipment and its accessories are made of various types of material, such as metal and plastic. Defective components must be disposed of as special waste. Ask your dealer or your local council.

XIII. Troubleshooting

The table below contains a list of fault symptoms and explains what you can do to remedy the problem if your equipment fails to work properly. If the problem still persists after working through the list, please contact your nearest service workshop.

Important hint in case of sending the equipment to a service station:

Due to security reasons please see to it that the equipment is sent back free of oil and petrol!

Fault	Possible cause	Remedy
5 in 1 Petrol Tool does not start.	<ul style="list-style-type: none"> Air filter is contaminated. Petrol filter is blocked. Lack of petrol supply. Fault in the petrol line. Starting device is faulty. Engine stalled. Spark plug cap not attached. No spark. Engine faulty. Carburetor faulty 	<ul style="list-style-type: none"> Clean/replace the air filter. Clean or renew the petrol filter. Re-fuel. Check the petrol line for kinks or damage. Contact the service centre. Remove the spark plug, clean and dry it; then pull the starter rope several times; re-fix the spark plug. Check the correct position of the spark plug cap. Clean the spark plug or replace it, if applicable. Check the ignition cable for damage. Contact the service centre. Contact the service centre.
5 in 1 Petrol Tool starts but stops again.	<ul style="list-style-type: none"> Wrong carburetor setting (idle speed). 	<ul style="list-style-type: none"> Contact the service centre.
Engine starts but the cutting tool stops.	<ul style="list-style-type: none"> Cutting tool blocked. Internal fault (drive shaft, gearbox). Clutch faulty. 	<ul style="list-style-type: none"> Turn off engine and remove object. Contact the service centre. Contact the service centre.

5 in 1 Petrol Tool works with interruptions (sputtering).	<ul style="list-style-type: none"> • Carburetor set up incorrectly. • Spark plug is sooty. • On/off switch faulty. 	<ul style="list-style-type: none"> • Contact the service centre. • Clean the spark plug or replace it. • Contact the service centre.
Smoke is generated.	<ul style="list-style-type: none"> • Wrong petrol mix. • Carburetor set up incorrectly. 	<ul style="list-style-type: none"> • Use two-stroke mixture at a ratio of 40:1. • Contact the service centre.
5 in 1 Petrol Tool does not work at full power.	<ul style="list-style-type: none"> • 5 in 1 Petrol Tool is overloaded. • Air filter is contaminated. • Carburetor set up incorrectly. • Silencer is blocked. 	<ul style="list-style-type: none"> • Do not use force during mowing/trimming. • Clean the air filter or replace it. • Contact the service centre. • Check the exhaust.
Brush cutter does not work at full power.	<ul style="list-style-type: none"> • Blades are blunt or damaged. • Cut material is too high (5 in 1 Petrol Tool overload). 	<ul style="list-style-type: none"> • Sharpen or replace blades. • Cut the grass in phases.
Grass trimmer does not work at full power.	<ul style="list-style-type: none"> • Cutting line too short or damaged. • 5 in 1 Petrol Tool is overloaded because the grass is too high. 	<ul style="list-style-type: none"> • Feed more cutting line through or replace it. • Cut the grass in phases.
Cutting line cannot be fed through.	<ul style="list-style-type: none"> • Spool empty. 	<ul style="list-style-type: none"> • Replace spool.
Pole saw does not saw, it plucks or vibrates.	<ul style="list-style-type: none"> • Chain tension too high. • Chain blunt. • Chain attached incorrectly. • Chain worn. 	<ul style="list-style-type: none"> • Check and reset chain tension. • Have the chain sharpened or replace it. • Re-attach the chain. • Replace the chain.
Saw chain becomes hot or saw chain lubrication does not work.	<ul style="list-style-type: none"> • No oil in the tank. • Oil line blocked. • Chain tension too high. • Chain blunt. 	<ul style="list-style-type: none"> • Refill oil. • Clean the oil line. • Set the chain tension. • Have the chain sharpened or replace it.



GARDENLINE® Garden 5 in 1 Petrol Tool

Repair and Refurbished Goods or Parts Notice

Unfortunately, from time to time, faulty products are manufactured which need to be returned to the Supplier for repair.

Please be aware that if your product is capable of retaining user-generated data (such as files stored on a computer hard drive, telephone numbers stored on a mobile telephone, songs stored on a portable media player, games saved on a games console or files stored on a USB memory stick) during the process of repair, some or all of your stored data may be lost.

We recommend you save this data elsewhere prior to sending the product for repair.

You should also be aware that rather than repairing goods, we may replace them with refurbished goods of the same type or use refurbished parts in the repair process.

Please be assured though, refurbished parts or replacements are only used where they meet ALDI's stringent quality specifications.

If at any time you feel your repair is being handled unsatisfactorily, you may escalate your complaint. Please telephone us on 1300 855 831 or write to us at:

RossMac Pty. Ltd.



P.O. Box 261, Essendon North, Victoria, 3041

Telephone: 1300 855 831

Operating hours: Monday - Friday 08:30am-6:00pm

Email: support@schepach.com.au

AFTER SALES SUPPORT

  1300 855 831

AUS Hotline Costs: Local rate for landline calls*
*Charges may vary dependent upon network operator or mobile network provider.

 support@schepach.com.au

MODEL: Garden 5 in 1 Petrol Tool PRODUCT CODE: 58903 02/2018



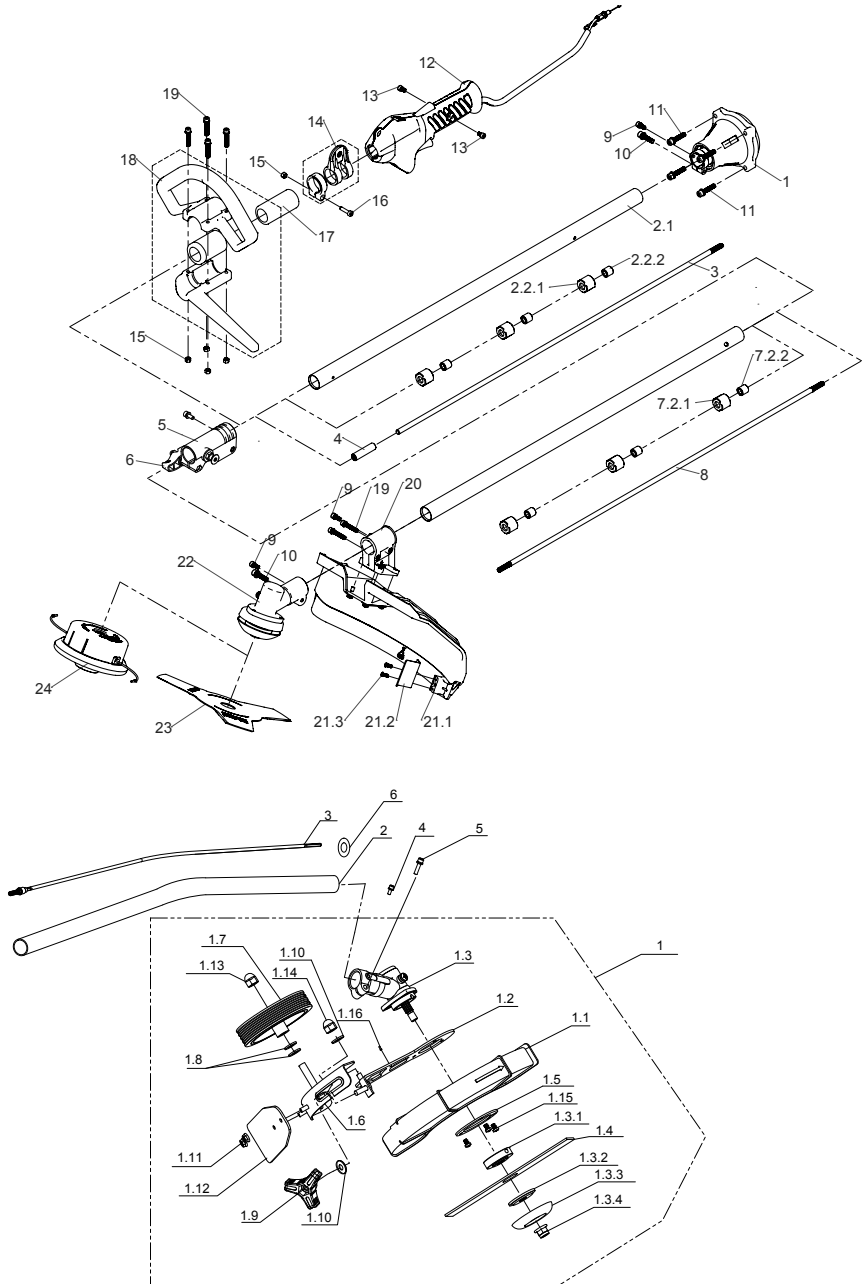

AFTER SALES SUPPORT

AUS 1300 855 831

AUS Hotline Costs: Local rate for landline calls*
 *Charges may vary dependent upon network operator or mobile network provider.

support@schepach.com.au

MODEL: Garden 5 in 1 Petrol Tool PRODUCT CODE: 58903 02/2018

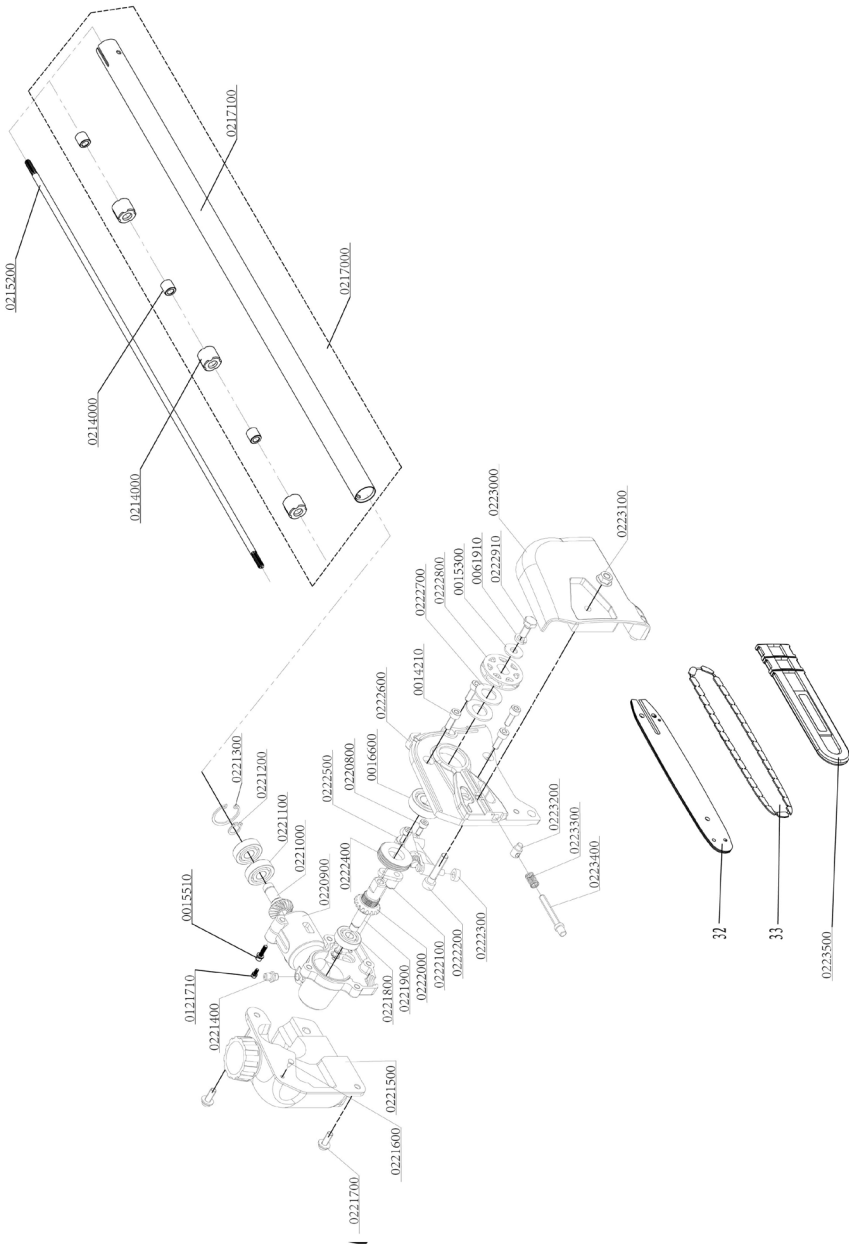

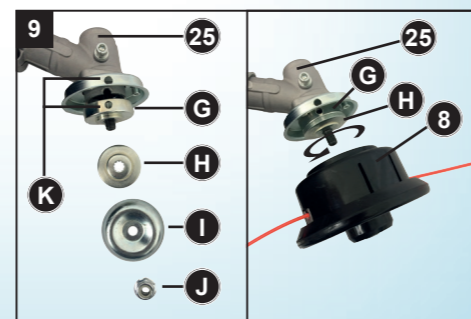
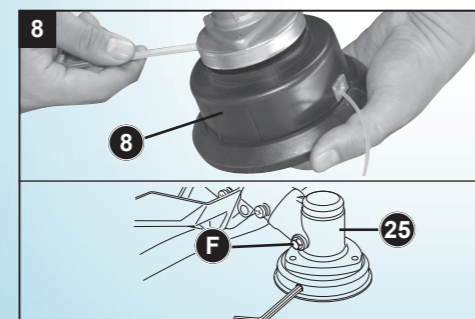
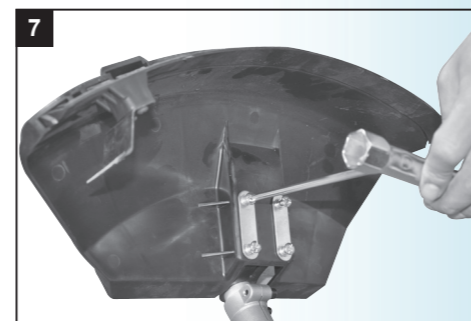
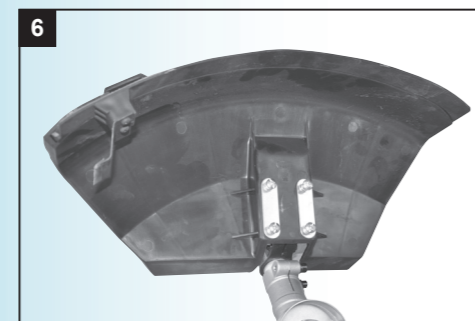
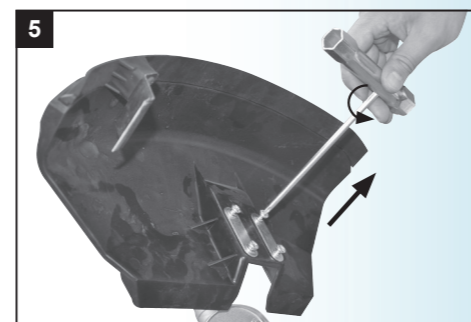
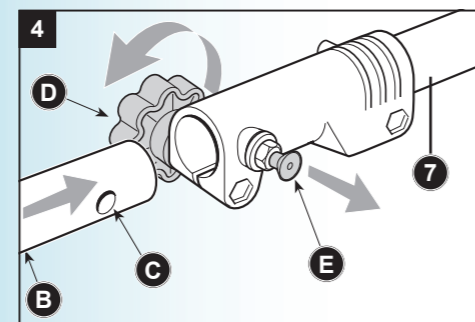
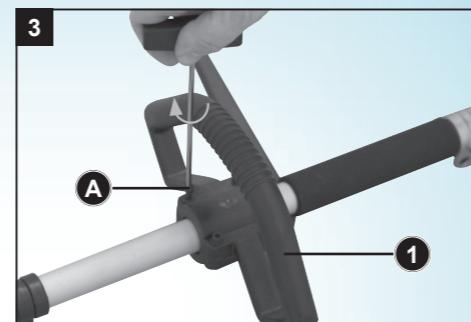
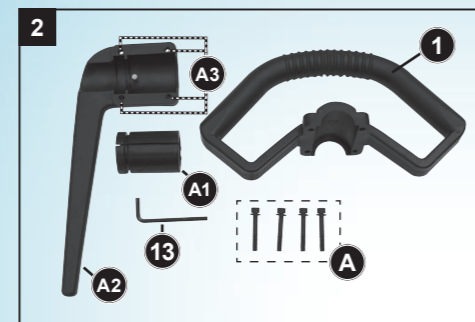
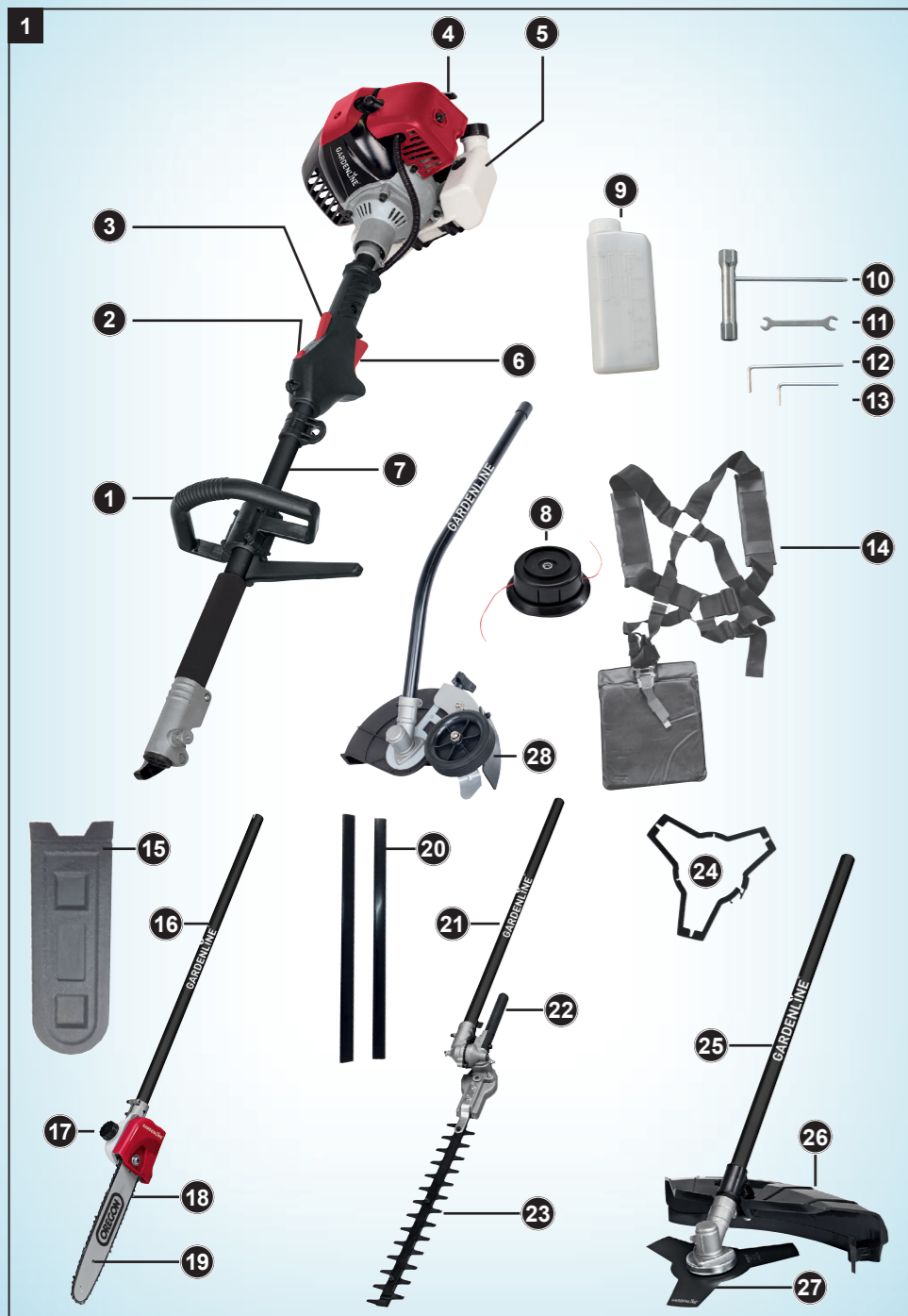

Contents of Box

- 1x Motor drive unit (7)
- 1x Front handle (1) consisting of:
(4 screws M5x35 (A), Front handle (1), Rubber insert (A1), Distance tool (A2), 4 Nuts M5 (A3) preassembled at Distance tool)
- 1x Grass trimmer (Nylon cutting head) (8)
- 1x Combined oil/petrol cylinder (9)
- 1x Spark plug wrench (10)
- 1x Open-ended spanner (8 mm / 10 mm) (11)
- 1x Allen key (size 5 mm) (12)
- 1x Allen key (size 4 mm) (13)
- 1x Carrying Belt (14)
- 1x Pole saw (16)
- 1x Protection shield Chain saw blade (15)
- 1x Protection shield Hedge trimmer (20)
- 1x Hedge trimmer (21)
- 1x Protection shield Brush cutter (24)
- 1x Brush cutter (25)
- 1x Protection shield (Brush cutter + Grass trimmer) (26)
- 1x Cutting blade (Brush cutter) (27)
- 1x Edger Combi tool (28)
- 1x User manual
- 1x Warranty card

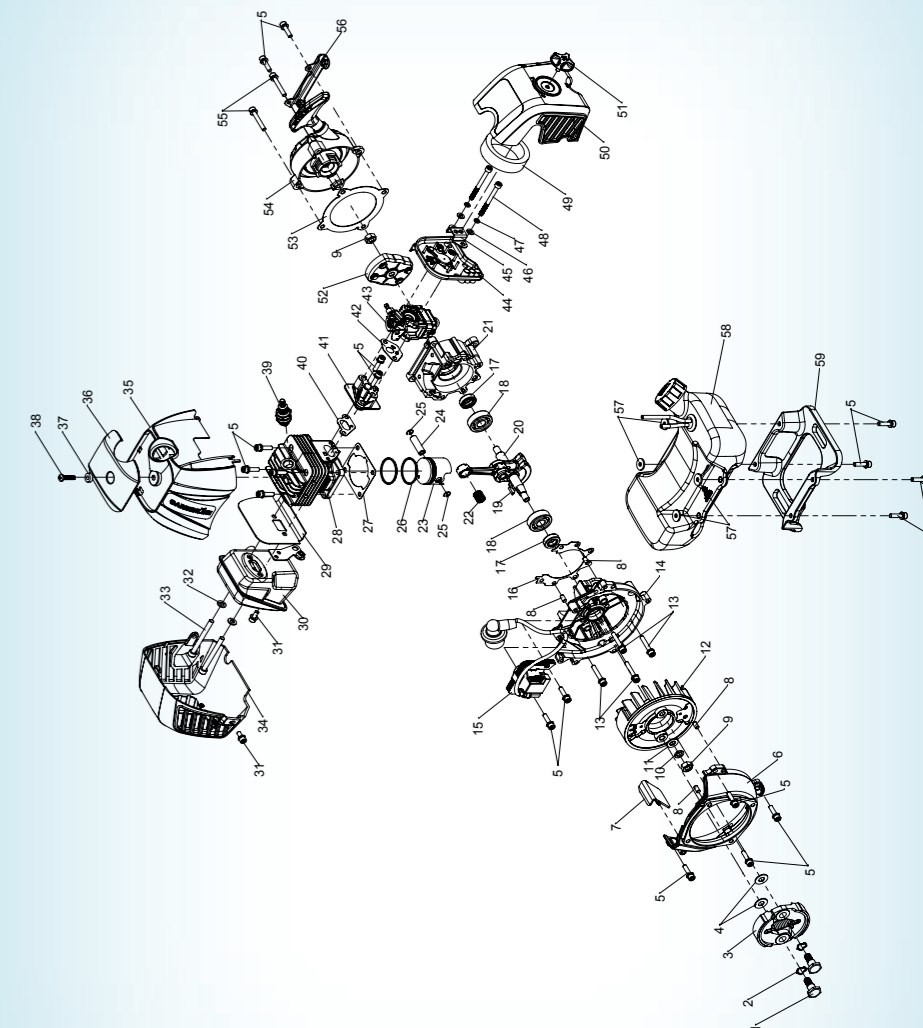

AFTER SALES SUPPORT

support@scheppach.com.au

AUS 1300 855 831

MODEL: Garden 5 in 1 Petrol Tool PRODUCT CODE: 58903 02/2018